



Test Report issued under the responsibility of:



TEST REPORT
IEC 60950-1
Information technology equipment – Safety –
Part 1: General requirements

Report Number..... : TP12040340-ST
Date of issue..... : May 16, 2012
Total number of pages..... : 73 pages test report + Appendix 1, 2 pages + Appendix 2, 52 pages + Appendix 3, 1 page + Appendix 4, 1 page + Photos, 4 pages.

CB Testing Laboratory..... : Intertek Testing Services Taiwan Ltd.
Address..... : 5F, No. 423, Ruiguang Rd., Neihu District, Taipei 114, Taiwan

Applicant's name..... : ENG Electric Co., Ltd.
Address..... : 5F, No. 536, Sec. 1, Min Sheng N. Rd., Kweishan Hsiang, Taoyuan Hsien, Taiwan

Manufacturer's name..... : Same as applicant
Address..... : Same as applicant

Test specification:
Standard..... : IEC 60950-1:2005 (2nd Edition); Am 1: 2009 and/or EN 60950-1:2006 + A11: 2009 + A1: 2010 + A12: 2011

Test procedure..... : CB Scheme
Non-standard test method..... : N/A

Test Report Form No..... : IEC60950_1B
Test Report Form(s) Originator..... : SGS Fimko Ltd
Master TRF..... : Dated 2010-04

Copyright © 2010 Worldwide System for Conformity Testing and Certification of Electrotechnical Equipment and Components (IECEE), Geneva, Switzerland. All rights reserved.



This publication may be reproduced in whole or in part for non-commercial purposes as long as the IECEE is acknowledged as copyright owner and source of the material. IECEE takes no responsibility for and will not assume liability for damages resulting from the reader's interpretation of the reproduced material due to its placement and context.

If this Test Report Form is used by non-IECEE members, the IECEE/IEC logo and the reference to the CB Scheme procedure shall be removed.

This report is not valid as a CB Test Report unless signed by an approved CB Testing Laboratory and appended to a CB Test Certificate issued by an NCB in accordance with IECEE 02.

Test item description..... : Power supply for business machine
Trade Mark..... : ENG
Manufacturer..... : Same as applicant
Model/Type reference..... : 3A-186DA**, 3A-186DA**A (see general product information on page 8)
Ratings..... : Input: 100 – 240 Vac, 50 – 60 Hz, 0.5 A
Output: 5-15 Vdc, 1.2 – 3.6 A, max. 18 VA
Class II

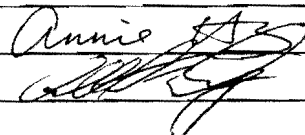

Testing procedure and testing location:		
<input checked="" type="checkbox"/>	CB Testing Laboratory:	Intertek Testing Services Taiwan Ltd.
Testing location/ address		5F, No. 423, Ruiguang Rd., Neihu District, Taipei 114, Taiwan
<input type="checkbox"/>	Associated CB Laboratory:	
Testing location/ address		
Tested by (name + signature)		Annie Hsu 
Approved by (name + signature)		Albert Wang 
<input type="checkbox"/>	Testing procedure: TMP	
Testing location/ address		
Tested by (name + signature)		
Approved by (name + signature)		
<input type="checkbox"/>	Testing procedure: WMT	
Testing location/ address		
Tested by (name + signature)		
Witnessed by (name + signature)		
Approved by (name + signature)		
<input type="checkbox"/>	Testing procedure: SMT	
Testing location/ address		
Tested by (name + signature)		
Approved by (name + signature)		
Supervised by (name + signature)		
<input type="checkbox"/>	Testing procedure: RMT	
Testing location/ address		
Tested by (name + signature)		
Approved by (name + signature)		
Supervised by (name + signature)		

<p>List of Attachments (including a total number of pages in each attachment):</p> <p>Appendix 1 (2 pages) – Appended table. Appendix 2 (52 pages) – National differences. Appendix 3 (1 page) – Circuit diagram. Appendix 4 (1 page) – PCB layout. Photos (4 pages)</p>

<p>Summary of testing:</p>	
<p>Tests performed (name of test and test clause):</p> <p>The sample(s) tested complies with the requirements of IEC 60950-1:2005+A1:2009 (2nd edition) and EN 60950-1:2006+A11:2009+A1:2010 + A12: 2011.</p> <p>1.6.2 Input current test 1.7.11 Marking durability test 2.1.1.1 b Finger test 2.1.1.1 c Pin test 2.1.1.5 Energy hazards test 2.1.1.7 Stored discharge on capacitors test 2.2.2 Voltages under normal conditions test 2.2.3 Voltages under fault conditions test 2.4 Limited current circuits test 2.5 Limited power sources test 2.9.2 Humidity condition test 2.10.2 Determination of working voltage test 2.10.3, 2.10.4 Clearances and creepage distances measurement 2.10.5.6 Solid insulation measurement 4.2.2 Mechanical Strength – 10 N Force test 4.2.4 Mechanical Strength – 250 N Force test 4.2.5 Mechanical Strength – Steel Ball Impact test 4.2.6 Mechanical Strength – drop test</p>	<p>Testing location:</p> <p>Intertek Testing Services Taiwan Ltd.</p>



<p>Tests performed (name of test and test clause) (cont.):</p> <p>4.2.7 Mechanical Strength – stress relief test</p> <p>4.5.2 Normal operating test</p> <p>4.5.5 Ball pressure test</p> <p>5.1 Touch current test</p> <p>5.2 Electric strength test</p> <p>5.3 Abnormal operating and fault conditions test</p>	
<p>Summary of compliance with National Differences</p> <p>For IEC 60950-1:2005+A1:2009 (2nd edition) and EN 60950-1:2006+A11:2009+A1:2010+A12:2011: Group differences, special national deviations of all CENELEC countries, CA, AU, KR and US. Explanation of CENELEC countries: Austria (AT), Belgium (BE), Bulgaria (BG), Croatia (HR), Cyprus (CY), Czech Republic (CZ), Denmark (DK), Estonia (EE), Finland (FI), France (FR), Germany (DE), Greece (GR), Hungary (HU), Iceland (IS), Ireland (IE), Italy (IT), Latvia (LV), Lithuania (LT), Luxembourg (LU), Malta (MT), Netherlands (NL), Norway (NO), Poland (PL), Portugal (PT), Romania (RO), Spain (ES), Slovakia (SK), Slovenia (SI), Sweden (SE), Switzerland (CH) and United Kingdom (GB). Explanation of used codes for National Differences: Korea (KR), Australia (AU).</p> <p>Explanation of used codes for National Differences: Australia (AU), Canada (CA), Korea (KR) and United States of America (US).</p> <p>Additionally evaluated the National Differences for IEC 60950-1:2001 (1st edition) by the customer's request: Japan (JP).</p> <p>Additionally evaluated the National Differences for IEC 60950:1999 (3rd edition) by the customer's request: China (CN).</p> <p>All country differences listed in the CB Bulletin are covered by the Common Modifications, Special National Conditions, National Deviations, and National Requirements noted above except for the following countries which are documented in Country Differences. Attachments attached to this report: refer to appendix 2 for details.</p> <p>Compliance with the National requirements of "(countries)" as given in CB Bulletin "(112A)" dated December 2006 and IECEE website dated March 2012 were also confirmed.</p>	

Copy of marking plate



(Representative)





SWITCH-MODE POWER SUPPLY
 MODEL NO.: 3A-186DA05
 INPUT: 100 – 240 V \sim , 50 – 60 Hz, 0.5 A
 OUTPUT: 5 V \equiv 3.6 A
 FOR I.T.E. USE ONLY

SWITCH-MODE POWER SUPPLY
 MODEL NO.: 3A-186DA05A
 INPUT: 100 – 240 V \sim , 50 – 60 Hz, 0.5 A
 OUTPUT: 5 V \equiv 3.0 A
 FOR I.T.E. USE ONLY

SWITCH-MODE POWER SUPPLY
 MODEL NO.: 3A-186DA15
 INPUT: 100 – 240 V \sim , 50 – 60 Hz, 0.5 A
 OUTPUT: 15 V \equiv 1.2 A
 FOR I.T.E. USE ONLY

SWITCH-MODE POWER SUPPLY
 MODEL NO.: 3A-186DA12
 INPUT: 100 – 240 V \sim , 50 – 60 Hz, 0.5 A
 OUTPUT: 12 V \equiv 1.5 A
 FOR I.T.E. USE ONLY



Note:

The above markings are the minimum requirements required by the safety standard. For the final production samples, the additional markings which do not give rise to misunderstanding may be added



Test item particulars	
Equipment mobility	<input checked="" type="checkbox"/> movable <input type="checkbox"/> hand-held <input checked="" type="checkbox"/> transportable <input type="checkbox"/> stationary <input type="checkbox"/> for building-in <input type="checkbox"/> direct plug-in
Connection to the mains.....	<input checked="" type="checkbox"/> pluggable equipment <input checked="" type="checkbox"/> type A <input type="checkbox"/> type B <input type="checkbox"/> permanent connection <input checked="" type="checkbox"/> detachable power supply cord <input type="checkbox"/> non-detachable power supply cord <input type="checkbox"/> not directly connected to the mains
Operating condition	<input checked="" type="checkbox"/> continuous <input type="checkbox"/> rated operating / resting time:
Access location	<input checked="" type="checkbox"/> operator accessible <input type="checkbox"/> restricted access location
Over voltage category (OVC)	<input type="checkbox"/> OVC I <input checked="" type="checkbox"/> OVC II <input type="checkbox"/> OVC III <input type="checkbox"/> OVC IV <input type="checkbox"/> other: Not direct connected to the mains
Mains supply tolerance (%) or absolute mains supply values	+6 %, + 10 % and – 10 % (the test voltage + 10 % is required by the manufacturer)
Tested for IT power systems	<input checked="" type="checkbox"/> Yes <input type="checkbox"/> No
IT testing, phase-phase voltage (V)	230 V
Class of equipment	<input type="checkbox"/> Class I <input checked="" type="checkbox"/> Class II <input type="checkbox"/> Class III <input type="checkbox"/> Not classified
Considered current rating (A)	16 A or 20 A (for Canada and US)
Pollution degree (PD)	<input type="checkbox"/> PD 1 <input checked="" type="checkbox"/> PD 2 <input type="checkbox"/> PD 3
IP protection class	IPX0
Altitude during operation (m)	< 2000 m
Altitude of test laboratory (m)	< 2000 m
Mass of equipment (kg)	Approx. 0.15 kg
Possible test case verdicts:	
- test case does not apply to the test object.....	N/A
- test object does meet the requirement	P (Pass)
- test object does not meet the requirement	F (Fail)
Testing	
Date of receipt of test item	April 26, 2012
Date(s) of performance of tests	April 26, 2012 – May 3, 2012



General remarks:

The test results presented in this report relate only to the object tested.
This report shall not be reproduced, except in full, without the written approval of the Issuing testing laboratory.

"(see Enclosure #)" refers to additional information appended to the report.

"(see appended table)" refers to a table appended to the report.

Throughout this report a comma / point is used as the decimal separator.

This report is for the exclusive use of Intertek's Client and is provided pursuant to the agreement between Intertek and its Client. Intertek's responsibility and liability are limited to the terms and conditions of the agreement. Intertek assumes no liability to any party, other than to the Client in accordance with the agreement, for any loss, expense or damage occasioned by the use of this report. Only the Client is authorized to permit copying or distribution of this report and then only in its entirety. Any use of the Intertek name or one of its marks for the sale or advertisement of the tested material, product or service must first be approved in writing by Intertek. The observations and test results in this report are relevant only to the sample tested. This report by itself does not imply that the material, product, or service is or has ever been under an Intertek certification program.

When determining the test conclusion, the Measurement Uncertainty of test has been considered.

Manufacturer's Declaration per sub-clause 6.2.5 of IEC60950-1:

The application for obtaining a CB Test Certificate includes more than one factory location and a declaration from the Manufacturer stating that the sample(s) submitted for evaluation is (are) representative of the products from each factory has been provided : Yes Not applicable

When differences exist; they shall be identified in the General product information section.

Name and address of factory (ies).....: Shenzhen ENG Electronics Co., Ltd.
Block B, Nuclear Group Industrial District, Baishixia, Fuyun Town, Bao'an, Shenzhen, China

General product information:

The equipment is a switching power adaptor for ITE and indoor use only. The appliance inlet is considered as the disconnect device, and the equipment is considered as movable (transportable) and Class II equipment.

The equipment was submitted and evaluated for maximum manufacturer’s recommended ambient of 40 °C.

The equipment intended to be used in tropical conditions.

The enclosures fixed together by ultrasonic welding.

Explanation of model designation 3A-186DA**:

The 1st to 2nd “**” denotes the output voltage, which can be “05” (5Vdc), “06” (6Vdc), “12” (12Vdc) or “15” (15Vdc).

Explanation of model designation 3A-186DA**A:

The 1st to 2nd “**” denotes the output voltage, which can be “05” (5Vdc).

Model 3A-186DA05A are similar to model 3A-186DA05, those models use the same enclosure, main board and construction, except for output current different.

The model designations and ratings are detailed as follows:

Model Designation	OUTPUT		
	VOLTAGE(V)	CURRENT(A)	POWER (VA)
3A-186DA05A	5	3.0	15
3A-186DA05	5	3.6	18
3A-186DA06	6	3.0	18
3A-186DA12	12	1.5	18
3A-186DA15	15	1.2	18

All tests are performed on Models 3A-186DA05, 3A-186DA15 and compliance for sub-clause 2.5 Limit Power Source as the representative of these families; the familial models are based on same circuit diagram, PCB layout and enclosure.

Abbreviations used in the report:

- | | | | |
|--------------------------------------|------|----------------------------|-------|
| - normal conditions | N.C. | - single fault conditions | S.F.C |
| - functional insulation | FI | - basic insulation | BI |
| - double insulation | DI | - supplementary insulation | SI |
| - between parts of opposite polarity | BOP | - reinforced insulation | RI |

Indicate used abbreviations (if any)

IEC 60950-1/Am1			
Clause	Requirement + Test	Result - Remark	Verdict
1	GENERAL		
1.5	Components		P
1.5.1	General		P
	Comply with IEC 60950-1 or relevant component standard	(see appended table 1.5.1)	P
1.5.2	Evaluation and testing of components	Components, which are certified to IEC and/or national standards, are used correctly within their ratings. Components not covered by IEC standards are tested under the conditions present in the equipment	P
1.5.3	Thermal controls	No such component within the EUT	N/A
1.5.4	Transformers	(see also Annex C)	P
1.5.5	Interconnecting cables	The output is evaluated at the relevant parts of this report	P
1.5.6	Capacitors bridging insulation	Approved X / Y capacitors (see appended table 1.5.1)	P
1.5.7	Resistors bridging insulation	See below	P
1.5.7.1	Resistors bridging functional, basic or supplementary insulation	Resistors are bridging functional insulation only and which are evaluated in this test report	P
1.5.7.2	Resistors bridging double or reinforced insulation between a.c. mains and other circuits		N/A
1.5.7.3	Resistors bridging double or reinforced insulation between a.c. mains and antenna or coaxial cable		N/A
1.5.8	Components in equipment for IT power systems		N/A
1.5.9	Surge suppressors	(see appended table 1.5.1)	P
1.5.9.1	General	Approved Varistor comply with Annex Q used in primary circuit (see appended table 1.5.1)	P
1.5.9.2	Protection of VDRs	A fuse is connected in series with VDR	P

IEC 60950-1/Am1			
Clause	Requirement + Test	Result - Remark	Verdict
1.5.9.3	Bridging of functional insulation by a VDR	Approved Varistor locate between mains	P
1.5.9.4	Bridging of basic insulation by a VDR		N/A
1.5.9.5	Bridging of supplementary, double or reinforced insulation by a VDR		N/A

1.6	Power interface		P
1.6.1	AC power distribution systems	TN, TT or IT (only for Norway)	P
1.6.2	Input current	(see appended table 1.6.2)	P
1.6.3	Voltage limit of hand-held equipment	The EUT is not hand-held equipment	N/A
1.6.4	Neutral conductor		P

1.7	Marking and instructions		P
1.7.1	Power rating and identification markings	See below	P
1.7.1.1	Power rating marking	See below	P
	Multiple mains supply connections.....:	The EUT is not such type equipment	N/A
	Rated voltage(s) or voltage range(s) (V)	100 – 240 Vac	P
	Symbol for nature of supply, for d.c. only.....:	The EUT is supplied by AC mains	P
	Rated frequency or rated frequency range (Hz):	50 – 60 Hz	P
	Rated current (mA or A)	0.5 A	P
1.7.1.2	Identification markings	See below	P
	Manufacturer's name or trade-mark or identification mark	ENG	P
	Model identification or type reference	3A-186DA**, 3A-186DA**A	P
	Symbol for Class II equipment only		P
	Other markings and symbols	Symbols are used according to IEC 60417-1	P
1.7.2	Safety instructions and marking	The English for "I.T.E. POWER SUPPLY" will be provided with the unit	P
1.7.2.1	General		P

IEC 60950-1/Am1			
Clause	Requirement + Test	Result - Remark	Verdict
1.7.2.2	Disconnect devices	Approved appliance coupler is provided	P
1.7.2.3	Overcurrent protective device		N/A
1.7.2.4	IT power distribution systems	For Norway compliance has to be evaluated during the national approval	N/A
1.7.2.5	Operator access with a tool	No such area	N/A
1.2.7.6	Ozone	The EUT does not produce such thing	N/A
1.7.3	Short duty cycles	The EUT is continuous operating type	N/A
1.7.4	Supply voltage adjustment	Only one power supply voltage range	N/A
	Methods and means of adjustment; reference to installation instructions		N/A
1.7.5	Power outlets on the equipment	No such component within the EUT	N/A
1.7.6	Fuse identification (marking, special fusing characteristics, cross-reference)	The "F1" and "T1A/250V" are marked adjacent to the main fuse	P
1.7.7	Wiring terminals		N/A
1.7.7.1	Protective earthing and bonding terminals		N/A
1.7.7.2	Terminals for a.c. mains supply conductors		N/A
1.7.7.3	Terminals for d.c. mains supply conductors		N/A
1.7.8	Controls and indicators		N/A
1.7.8.1	Identification, location and marking	No controls and switches within the EUT	N/A
1.7.8.2	Colours		N/A
1.7.8.3	Symbols according to IEC 60417		N/A
1.7.8.4	Markings using figures	No figures used as marking	N/A
1.7.9	Isolation of multiple power sources	Only one power supply	N/A
1.7.10	Thermostats and other regulating devices	No such device within the EUT	N/A

IEC 60950-1/Am1			
Clause	Requirement + Test	Result - Remark	Verdict
1.7.11	Durability	After rubbing test by water and petroleum spirit, the marking still legible; it is not easily possible to remove the marking plate and show no curling	P
1.7.12	Removable parts	Marking plate is not placed on removable parts	P
1.7.13	Replaceable batteries	No such device within the EUT	N/A
	Language(s)		—
1.7.14	Equipment for restricted access locations	The EUT is not such type	N/A

IEC 60950-1/Am1			
Clause	Requirement + Test	Result - Remark	Verdict
2	PROTECTION FROM HAZARDS		P
2.1	Protection from electric shock and energy hazards		P
2.1.1	Protection in operator access areas		P
2.1.1.1	Access to energized parts	See comment below	P
	Test by inspection	The concerned hazardous parts are not accessible	P
	Test with test finger (Figure 2A)	The concerned hazardous parts are not accessible	P
	Test with test pin (Figure 2B)	Hazardous live parts are not accessible	P
	Test with test probe (Figure 2C)	No TNV circuit within the EUT	N/A
2.1.1.2	Battery compartments	No battery compartment within the EUT	N/A
2.1.1.3	Access to ELV wiring	No internal wiring at ELV	N/A
	Working voltage (V _{peak} or V _{rms}); minimum distance through insulation (mm)		—
2.1.1.4	Access to hazardous voltage circuit wiring		N/A
2.1.1.5	Energy hazards	(see appended table 2.1.1.5)	P
2.1.1.6	Manual controls	No such devices	N/A
2.1.1.7	Discharge of capacitors in equipment		P
	Measured voltage (V); time-constant (s)	(see appended table 2.1.1.7)	—
2.1.1.8	Energy hazards – d.c. mains supply	Not direct connected to the d.c. mains	N/A
	a) Capacitor connected to the d.c. mains supply ..:		N/A
	b) Internal battery connected to the d.c. mains supply		N/A
2.1.1.9	Audio amplifiers	No such device within the EUT	N/A
2.1.2	Protection in service access areas		N/A
2.1.3	Protection in restricted access locations		N/A
2.2	SELV circuits		P
2.2.1	General requirements	See below	P

IEC 60950-1/Am1			
Clause	Requirement + Test	Result - Remark	Verdict
2.2.2	Voltages under normal conditions (V)	All accessible voltages are less than 42.4 V _{peak} or 60 V _{dc} and are classified as SELV circuits	P
2.2.3	Voltages under fault conditions (V)	Single fault did not cause excessive voltage in accessible SELV circuits. Limits of 71 V _{peak} and 120 V _{dc} were not exceeded within 0.2 s and limits 42.4 V _{peak} and 60 V _{dc} were not exceeded for longer than 0.2 s	P
2.2.4	Connection of SELV circuits to other circuits	SELV circuits are only connected to other SELV circuits	P

2.3	TNV circuits		N/A
2.3.1	Limits	No TNV circuit within the EUT	N/A
	Type of TNV circuits		—
2.3.2	Separation from other circuits and from accessible parts		N/A
2.3.2.1	General requirements		N/A
2.3.2.2	Protection by basic insulation		N/A
2.3.2.3	Protection by earthing		N/A
2.3.2.4	Protection by other constructions		N/A
2.3.3	Separation from hazardous voltages		N/A
	Insulation employed		—
2.3.4	Connection of TNV circuits to other circuits		N/A
	Insulation employed		—
2.3.5	Test for operating voltages generated externally		N/A

2.4	Limited current circuits		P
2.4.1	General requirements		P
2.4.2	Limit values		P
	Frequency (Hz).....	(see appended table 2.4.2)	—
	Measured current (mA)	(see appended table 2.4.2)	—

IEC 60950-1/Am1			
Clause	Requirement + Test	Result - Remark	Verdict
	Measured voltage (V)	(see appended table 2.4.2)	—
	Measured circuit capacitance (nF or μF)	(see appended table 2.4.2)	—
2.4.3	Connection of limited current circuits to other circuits	Output circuit as limited current circuits to other circuits	P

2.5	Limited power sources		P
	a) Inherently limited output		P
	b) Impedance limited output		N/A
	c) Regulating network limited output under normal operating and single fault condition		P
	d) Overcurrent protective device limited output		N/A
	Max. output voltage (V), max. output current (A), max. apparent power (VA)	(see appended table 2.5)	—
	Current rating of overcurrent protective device (A) .:		—
	Use of integrated circuit (IC) current limiters		—

2.6	Provisions for earthing and bonding		N/A
2.6.1	Protective earthing	Class II equipment	N/A
2.6.2	Functional earthing		N/A
2.6.3	Protective earthing and protective bonding conductors		N/A
2.6.3.1	General		N/A
2.6.3.2	Size of protective earthing conductors		N/A
	Rated current (A), cross-sectional area (mm ²), AWG.....		—
2.6.3.3	Size of protective bonding conductors		N/A
	Rated current (A), cross-sectional area (mm ²), AWG.....		—
	Protective current rating (A), cross-sectional area (mm ²), AWG.....		—
2.6.3.4	Resistance of earthing conductors and their terminations; resistance (Ω), voltage drop (V), test current (A), duration (min)		N/A
2.6.3.5	Colour of insulation.....		N/A
2.6.4	Terminals		N/A

IEC 60950-1/Am1			
Clause	Requirement + Test	Result - Remark	Verdict
2.6.4.1	General		N/A
2.6.4.2	Protective earthing and bonding terminals		N/A
	Rated current (A), type, nominal thread diameter (mm).....:		—
2.6.4.3	Separation of the protective earthing conductor from protective bonding conductors		N/A
2.6.5	Integrity of protective earthing		N/A
2.6.5.1	Interconnection of equipment		N/A
2.6.5.2	Components in protective earthing conductors and protective bonding conductors		N/A
2.6.5.3	Disconnection of protective earth		N/A
2.6.5.4	Parts that can be removed by an operator		N/A
2.6.5.5	Parts removed during servicing		N/A
2.6.5.6	Corrosion resistance		N/A
2.6.5.7	Screws for protective bonding		N/A
2.6.5.8	Reliance on telecommunication network or cable distribution system		N/A

2.7	Overcurrent and earth fault protection in primary circuits		P
2.7.1	Basic requirements	Integral part of equipment	P
	Instructions when protection relies on building installation		N/A
2.7.2	Faults not simulated in 5.3.7		N/A
2.7.3	Short-circuit backup protection	Building installation is considered as the short-circuit backup protection	P
2.7.4	Number and location of protective devices	One current fuse (F1) is located in the Line pole of primary circuit	P
2.7.5	Protection by several devices	Only one protection device	N/A
2.7.6	Warning to service personnel	The EUT is not such kinds of design	N/A

2.8	Safety interlocks		N/A
2.8.1	General principles	No safety interlock or similar devices used within the EUT	N/A

IEC 60950-1/Am1			
Clause	Requirement + Test	Result - Remark	Verdict
2.8.2	Protection requirements		N/A
2.8.3	Inadvertent reactivation		N/A
2.8.4	Fail-safe operation		N/A
	Protection against extreme hazard		N/A
2.8.5	Moving parts		N/A
2.8.6	Overriding		N/A
2.8.7	Switches, relays and their related circuits		N/A
2.8.7.1	Separation distances for contact gaps and their related circuits (mm)		N/A
2.8.7.2	Overload test		N/A
2.8.7.3	Endurance test		N/A
2.8.7.4	Electric strength test		N/A
2.8.8	Mechanical actuators		N/A

2.9	Electrical insulation		P
2.9.1	Properties of insulating materials	No natural rubber, hygroscopic materials or asbestos are used as insulation	P
2.9.2	Humidity conditioning	48 hours	P
	Relative humidity (%), temperature (°C)	95 %, 30 °C	—
2.9.3	Grade of insulation	Considered	P
2.9.4	Separation from hazardous voltages	SELV circuits separated from primary by double / reinforce insulation	P
	Method(s) used	Method 1	—

2.10	Clearances, creepage distances and distances through insulation		P
2.10.1	General		P
2.10.1.1	Frequency	The frequency does not exceed 30 k Hz	P
2.10.1.2	Pollution degrees	Pollution degree 2	P
2.10.1.3	Reduced values for functional insulation	Refer sub-clause 5.3.4	P
2.10.1.4	Intervening unconnected conductive parts	No such conductive parts	P

IEC 60950-1/Am1			
Clause	Requirement + Test	Result - Remark	Verdict
2.10.1.5	Insulation with varying dimensions	Not applicable	N/A
2.10.1.6	Special separation requirements	No TNV circuit	N/A
2.10.1.7	Insulation in circuits generating starting pulses	No lamps	N/A
2.10.2	Determination of working voltage		P
2.10.2.1	General		P
2.10.2.2	RMS working voltage	(see appended table 2.10.2)	P
2.10.2.3	Peak working voltage	(see appended table 2.10.2)	P
2.10.3	Clearances		P
2.10.3.1	General		P
2.10.3.2	Mains transient voltages		P
	a) AC mains supply	Overvoltage Category II	P
	b) Earthed d.c. mains supplies		N/A
	c) Unearthed d.c. mains supplies		N/A
	d) Battery operation		N/A
2.10.3.3	Clearances in primary circuits	(see appended tables 2.10.3 and 2.10.4)	P
2.10.3.4	Clearances in secondary circuits	See sub-clause 5.3.4	P
2.10.3.5	Clearances in circuits having starting pulses	No such device within the EUT	N/A
2.10.3.6	Transients from a.c. mains supply	2500 V _{peak}	P
2.10.3.7	Transients from d.c. mains supply		N/A
2.10.3.8	Transients from telecommunication networks and cable distribution systems		N/A
2.10.3.9	Measurement of transient voltage levels		N/A
	a) Transients from a mains supply		N/A
	For an a.c. mains supply		N/A
	For a d.c. mains supply		N/A
	b) Transients from a telecommunication network :		N/A
2.10.4	Creepage distances		P
2.10.4.1	General		P
2.10.4.2	Material group and comparative tracking index		P

IEC 60950-1/Am1			
Clause	Requirement + Test	Result - Remark	Verdict
	CTI tests..... :	Considered as Material Group IIIb	—
2.10.4.3	Minimum creepage distances	(see appended tables 2.10.3 and 2.10.4)	P
2.10.5	Solid insulation		P
2.10.5.1	General		P
2.10.5.2	Distances through insulation		P
2.10.5.3	Insulating compound as solid insulation	No insulation compound	N/A
2.10.5.4	Semiconductor devices	Approved optocouplers (PC1) (see also appended table 1.5.1)	P
2.10.5.5.	Cemented joints		N/A
2.10.5.6	Thin sheet material – General	Insulation tapes provided reinforced insulation on the core of transformer	P
2.10.5.7	Separable thin sheet material	(see appended table 2.10.5)	P
	Number of layers (pcs)..... :	(see appended table 2.10.5)	—
2.10.5.8	Non-separable thin sheet material	See sub-clause 2.10.5.10	P
2.10.5.9	Thin sheet material – standard test procedure	See sub-clause 2.10.5.10	P
	Electric strength test		—
2.10.5.10	Thin sheet material – alternative test procedure		P
	Electric strength test	(see appended table 2.10.5)	—
2.10.5.11	Insulation in wound components	(see Annex U)	P
2.10.5.12	Wire in wound components	Approved triple insulation wire for T1 secondary winding	P
	Working voltage :	(see appended table 2.10.2)	P
	a) Basic insulation not under stress :		N/A
	b) Basic, supplementary, reinforced insulation :	(see Annex U)	N/A
	c) Compliance with Annex U :	3 layers	P
	Two wires in contact inside wound component; angle between 45° and 90° :	Physical separation in the form of insulating sleeving provided to relieve mechanical stress at the crossover point	P

IEC 60950-1/Am1			
Clause	Requirement + Test	Result - Remark	Verdict
2.10.5.13	Wire with solvent-based enamel in wound components	No such device within the EUT	N/A
	Electric strength test		—
	Routine test		N/A
2.10.5.14	Additional insulation in wound components		N/A
	Working voltage		N/A
	- Basic insulation not under stress		N/A
	- Supplementary, reinforced insulation		N/A
2.10.6	Construction of printed boards		P
2.10.6.1	Uncoated printed boards	(see appended table 2.10.3 and 2.10.4)	P
2.10.6.2	Coated printed boards		N/A
2.10.6.3	Insulation between conductors on the same inner surface of a printed board		N/A
2.10.6.4	Insulation between conductors on different layers of a printed board		N/A
	Distance through insulation		N/A
	Number of insulation layers (pcs).....		N/A
2.10.7	Component external terminations		N/A
2.10.8	Tests on coated printed boards and coated components		N/A
2.10.8.1	Sample preparation and preliminary inspection		N/A
2.10.8.2	Thermal conditioning		N/A
2.10.8.3	Electric strength test		N/A
2.10.8.4	Abrasion resistance test		N/A
2.10.9	Thermal cycling		N/A
2.10.10	Test for Pollution Degree 1 environment and insulating compound		N/A
2.10.11	Tests for semiconductor devices and cemented joints	Approved optocouplers (PC1) (see also appended table 1.5.1)	P
2.10.12	Enclosed and sealed parts		N/A

IEC 60950-1/Am1			
Clause	Requirement + Test	Result - Remark	Verdict
3	WIRING, CONNECTIONS AND SUPPLY		P
3.1	General		P
3.1.1	Current rating and overcurrent protection	(see appended table 1.5.1)	P
3.1.2	Protection against mechanical damage	Smooth wireways	P
3.1.3	Securing of internal wiring	All internal wirings are suitable fixed	P
3.1.4	Insulation of conductors		P
3.1.5	Beads and ceramic insulators		N/A
3.1.6	Screws for electrical contact pressure	No screws are used as electrical connections	N/A
3.1.7	Insulating materials in electrical connections		N/A
3.1.8	Self-tapping and spaced thread screws	No such screws are used	N/A
3.1.9	Termination of conductors	considered	P
	10 N pull test		P
3.1.10	Sleeving on wiring	No sleeving used as supplementary insulation	N/A
3.2	Connection to a mains supply		P
3.2.1	Means of connection	Approved appliance inlet is provided	P
3.2.1.1	Connection to an a.c. mains supply	An appliance inlet for connection of a detachable power supply cord	P
3.2.1.2	Connection to a d.c. mains supply		N/A
3.2.2	Multiple supply connections	There is only one supply connection for the EUT	N/A
3.2.3	Permanently connected equipment	The EUT is not such types	N/A
	Number of conductors, diameter of cable and conduits (mm)		—
3.2.4	Appliance inlets	Approved appliance inlet is provided (see appended table 1.5.1)	P
3.2.5	Power supply cords	See the Note in appended table 1.5.1	N/A
3.2.5.1	AC power supply cords		N/A

IEC 60950-1/Am1			
Clause	Requirement + Test	Result - Remark	Verdict
	Type		—
	Rated current (A), cross-sectional area (mm ²), AWG		—
3.2.5.2	DC power supply cords		N/A
3.2.6	Cord anchorages and strain relief		N/A
	Mass of equipment (kg), pull (N)		—
	Longitudinal displacement (mm)		—
3.2.7	Protection against mechanical damage		N/A
3.2.8	Cord guards		N/A
	Diameter or minor dimension D (mm); test mass (g)		—
	Radius of curvature of cord (mm)		—
3.2.9	Supply wiring space		N/A

3.3	Wiring terminals for connection of external conductors		N/A
3.3.1	Wiring terminals	No wiring terminal	N/A
3.3.2	Connection of non-detachable power supply cords		N/A
3.3.3	Screw terminals		N/A
3.3.4	Conductor sizes to be connected		N/A
	Rated current (A), cord/cable type, cross-sectional area (mm ²)		—
3.3.5	Wiring terminal sizes		N/A
	Rated current (A), type, nominal thread diameter (mm)		—
3.3.6	Wiring terminal design		N/A
3.3.7	Grouping of wiring terminals		N/A
3.3.8	Stranded wire		N/A

3.4	Disconnection from the mains supply		P
3.4.1	General requirement		P
3.4.2	Disconnect devices	The appliance coupler is considered as the disconnect devices	P

IEC 60950-1/Am1			
Clause	Requirement + Test	Result - Remark	Verdict
3.4.3	Permanently connected equipment	The EUT is not such equipment	N/A
3.4.4	Parts which remain energized		N/A
3.4.5	Switches in flexible cords		N/A
3.4.6	Number of poles – single-phase and d.c. equipment	Approved appliance coupler is provided	P
3.4.7	Number of poles – three-phase equipment		N/A
3.4.8	Switches as disconnect devices		N/A
3.4.9	Plugs as disconnect devices		N/A
3.4.10	Interconnected equipment		N/A
3.4.11	Multiple power sources	Only one supply source	N/A
3.5	Interconnection of equipment		P
3.5.1	General requirements		P
3.5.2	Types of interconnection circuits :	SELV to SELV	P
3.5.3	ELV circuits as interconnection circuits	No ELV interconnection circuits	N/A
3.5.4	Data ports for additional equipment		N/A

IEC 60950-1/Am1			
Clause	Requirement + Test	Result - Remark	Verdict
4	PHYSICAL REQUIREMENTS		P
4.1	Stability		P
	Angle of 10°	The mass of EUT is less than 7 kg	N/A
	Test force (N)	The mass of EUT is less than 25 kg and it is not floor-standing unit	N/A
4.2	Mechanical strength		P
4.2.1	General		P
	Rack-mounted equipment.	The EUT is not such type equipment	N/A
4.2.2	Steady force test, 10 N	The EUT is still complying with relevant requirements of this standard after 10 N force is applied to the components	P
4.2.3	Steady force test, 30 N		N/A
4.2.4	Steady force test, 250 N	The EUT is still complying with relevant requirements of this standard	P
4.2.5	Impact test	The EUT is still complying with relevant requirements of this standard	P
	Fall test	The EUT is still complying with relevant requirements of this standard	P
	Swing test		N/A
4.2.6	Drop test; height (mm)	1m, The EUT is still complying with relevant requirements of this standard	P
4.2.7	Stress relief test	93 °C, all the enclosure materials listed in the table 1.5.1 are tested	P
4.2.8	Cathode ray tubes	No such devices within the EUT	N/A
	Picture tube separately certified		N/A

IEC 60950-1/Am1			
Clause	Requirement + Test	Result - Remark	Verdict
4.2.9	High pressure lamps	No such devices within the EUT	N/A
4.2.10	Wall or ceiling mounted equipment; force (N):	The EUT is not such equipment	N/A
4.2.11	Rotating solid media	No such device within the EUT	N/A
	Test to cover on the door.....:		N/A

4.3	Design and construction		P
4.3.1	Edges and corners	The outer surface of the EUT is smoothed	P
4.3.2	Handles and manual controls; force (N):	No such device within the EUT	N/A
4.3.3	Adjustable controls	No such device within the EUT	N/A
4.3.4	Securing of parts	All parts are suitable fixed	P
4.3.5	Connection by plugs and sockets	No such devices within the EUT	N/A
4.3.6	Direct plug-in equipment		N/A
	Torque:		—
	Compliance with the relevant mains plug standard:		N/A
4.3.7	Heating elements in earthed equipment	No such device within the EUT	N/A
4.3.8	Batteries	No such device within the EUT	N/A
	- Overcharging of a rechargeable battery		N/A
	- Unintentional charging of a non-rechargeable battery		N/A
	- Reverse charging of a rechargeable battery		N/A
	- Excessive discharging rate for any battery		N/A
4.3.9	Oil and grease	No such material within the EUT	N/A
4.3.10	Dust, powders, liquids and gases	The EUT does not produce such thing	N/A

IEC 60950-1/Am1			
Clause	Requirement + Test	Result - Remark	Verdict
4.3.11	Containers for liquids or gases	No such device within the EUT	N/A
4.3.12	Flammable liquids	No such material is used	N/A
	Quantity of liquid (l)		N/A
	Flash point (°C)		N/A
4.3.13	Radiation		N/A
4.3.13.1	General		N/A
4.3.13.2	Ionizing radiation	The EUT does not generate ionizing radiation	N/A
	Measured radiation (pA/kg)		—
	Measured high-voltage (kV)		—
	Measured focus voltage (kV)		—
	CRT markings		—
4.3.13.3	Effect of ultraviolet (UV) radiation on materials	The EUT does not produce significant UV radiation	N/A
	Part, property, retention after test, flammability classification		N/A
4.3.13.4	Human exposure to ultraviolet (UV) radiation	The EUT does not produce significant UV radiation	N/A
4.3.13.5	Lasers (including laser diodes) and LEDs		N/A
4.3.13.5.1	Lasers (including laser laser diodes)	No such device within the EUT	N/A
	Laser class		—
4.3.13.5.2	Light emitting diodes (LEDs)		—
4.3.13.6	Other types	No such device within the EUT	N/A

4.4	Protection against hazardous moving parts		N/A
4.4.1	General		N/A
4.4.2	Protection in operator access areas	No hazardous moving parts within the EUT	N/A
	Household and home/office document/media shredders	The EUT is not such type equipment	N/A
4.4.3	Protection in restricted access locations	No hazardous moving parts within the EUT	N/A

IEC 60950-1/Am1			
Clause	Requirement + Test	Result - Remark	Verdict
4.4.4	Protection in service access areas	No hazardous moving parts within the EUT	N/A
4.4.5	Protection against moving fan blades	No hazardous moving parts within the EUT	N/A
4.4.5.1	General		N/A
	Not considered to cause pain or injury. A).....:		N/A
	Is considered to cause pain, not injury. B)		N/A
	Considered to cause injury. C)		N/A
4.4.5.2	Protection for users		N/A
	Use of symbol or warning		N/A
4.4.5.3	Protection for service persons		N/A
	Use of symbol or warning		N/A
4.5	Thermal requirements		P
4.5.1	General	Considered	P
4.5.2	Temperature tests	(see appended table 4.5)	P
	Normal load condition per Annex L	See Annex L.7	—
4.5.3	Temperature limits for materials	(see appended table 4.5)	P
4.5.4	Touch temperature limits	(see appended table 4.5)	P
4.5.5	Resistance to abnormal heat	(see appended table 4.5.5)	P
4.6	Openings in enclosures		P
4.6.1	Top and side openings		N/A
	Dimensions (mm)	No opening at all	—
4.6.2	Bottoms of fire enclosures		P
	Construction of the bottom, dimensions (mm) ...:	No opening at all	—
4.6.3	Doors or covers in fire enclosures	No door or cover is provided	N/A
4.6.4	Openings in transportable equipment	No opening at all	N/A
4.6.4.1	Constructional design measures		N/A
	Dimensions (mm)		—
4.6.4.2	Evaluation measures for larger openings		N/A
4.6.4.3	Use of metallized parts		N/A

IEC 60950-1/Am1			
Clause	Requirement + Test	Result - Remark	Verdict
4.6.5	Adhesives for constructional purposes	No barriers or screen provided to complying with the relevant requirements of sub-clause 4.6.1, 4.6.2 or 4.6.4	N/A
	Conditioning temperature (°C), time (weeks)..... :		—
4.7	Resistance to fire		P
4.7.1	Reducing the risk of ignition and spread of flame		P
	Method 1, selection and application of components wiring and materials	(see appended table 4.7)	P
	Method 2, application of all of simulated fault condition tests	(see appended table 5.3)	N/A
4.7.2	Conditions for a fire enclosure	Fire enclosure is provided	P
4.7.2.1	Parts requiring a fire enclosure		P
4.7.2.2	Parts not requiring a fire enclosure		N/A
4.7.3	Materials		P
4.7.3.1	General	Components and materials have adequate flammability classification	P
4.7.3.2	Materials for fire enclosures	(see appended table 1.5.1)	P
4.7.3.3	Materials for components and other parts outside fire enclosures	No parts outside the fire enclosure	N/A
4.7.3.4	Materials for components and other parts inside fire enclosures	(see appended table 1.5.1)	P
4.7.3.5	Materials for air filter assemblies	No such assembly within the EUT	N/A
4.7.3.6	Materials used in high-voltage components	No such component within the EUT	N/A

IEC 60950-1/Am1			
Clause	Requirement + Test	Result - Remark	Verdict
5	ELECTRICAL REQUIREMENTS AND SIMULATED ABNORMAL CONDITIONS		P
5.1	Touch current and protective conductor current		P
5.1.1	General		P
5.1.2	Configuration of equipment under test (EUT)	Equipment designed for connection to only one power source	P
5.1.2.1	Single connection to an a.c. mains supply		P
5.1.2.2	Redundant multiple connections to an a.c. mains supply	Single connection to a.c. mains supply	N/A
5.1.2.3	Simultaneous multiple connections to an a.c. mains supply	Single connection to a.c. mains supply	N/A
5.1.3	Test circuit	Test circuit as in figure 5A is used	P
5.1.4	Application of measuring instrument	Measuring instrument as in annex D.1 is used	P
5.1.5	Test procedure		P
5.1.6	Test measurements		P
	Supply voltage (V)	(see appended table 5.1)	—
	Measured touch current (mA)	(see appended table 5.1)	—
	Max. allowed touch current (mA)	(see appended table 5.1)	—
	Measured protective conductor current (mA)		—
	Max. allowed protective conductor current (mA)		—
5.1.7	Equipment with touch current exceeding 3,5 mA	The EUT is not such equipment	N/A
5.1.7.1	General		N/A
5.1.7.2	Simultaneous multiple connections to the supply		N/A
5.1.8	Touch currents to telecommunication networks and cable distribution systems and from telecommunication networks	No TNV circuit within the EUT	N/A
5.1.8.1	Limitation of the touch current to a telecommunication network or to a cable distribution system	No TNV circuit within the EUT	N/A
	Supply voltage (V)		—
	Measured touch current (mA)		—

IEC 60950-1/Am1			
Clause	Requirement + Test	Result - Remark	Verdict
	Max. allowed touch current (mA)		—
5.1.8.2	Summation of touch currents from telecommunication networks	No TNV circuit within the EUT	N/A
	a) EUT with earthed telecommunication ports		N/A
	b) EUT whose telecommunication ports have no reference to protective earth		N/A
5.2	Electric strength		P
5.2.1	General	(see appended table 5.2)	P
5.2.2	Test procedure	(see appended table 5.2)	P
5.3	Abnormal operating and fault conditions		P
5.3.1	Protection against overload and abnormal operation	(see appended table 5.3)	P
5.3.2	Motors		N/A
5.3.3	Transformers	(see appended table 5.3 and Annex C)	P
5.3.4	Functional insulation.....	Methods a), b) or c)	P
5.3.5	Electromechanical components	No such component within EUT	N/A
5.3.6	Audio amplifiers in ITE	No such component within EUT	N/A
5.3.7	Simulation of faults	(see appended table 5.3)	P
5.3.8	Unattended equipment	There are no thermostats and similar components within the EUT	N/A
5.3.9	Compliance criteria for abnormal operating and fault conditions	No fire propagated beyond the equipment, no molten metal was emitted and the enclosures no deformed	P
5.3.9.1	During the tests		P
5.3.9.2	After the tests	After test, the EUT still complies with relevant requirements of this standard	P

IEC 60950-1/Am1			
Clause	Requirement + Test	Result - Remark	Verdict
6	CONNECTION TO TELECOMMUNICATION NETWORKS		N/A
6.1	Protection of telecommunication network service persons, and users of other equipment connected to the network, from hazards in the equipment		N/A
6.1.1	Protection from hazardous voltages		N/A
6.1.2	Separation of the telecommunication network from earth		N/A
6.1.2.1	Requirements	No TNV circuit within the EUT	N/A
	Supply voltage (V)		—
	Current in the test circuit (mA)		—
6.1.2.2	Exclusions		N/A
6.2	Protection of equipment users from overvoltages on telecommunication networks		N/A
6.2.1	Separation requirements	No TNV circuit within the EUT	N/A
6.2.2	Electric strength test procedure		N/A
6.2.2.1	Impulse test		N/A
6.2.2.2	Steady-state test		N/A
6.2.2.3	Compliance criteria		N/A
6.3	Protection of the telecommunication wiring system from overheating		N/A
	Max. output current (A)	The EUT is not connected to telecommunication network	—
	Current limiting method		—

IEC 60950-1/Am1			
Clause	Requirement + Test	Result - Remark	Verdict
7	CONNECTION TO CABLE DISTRIBUTION SYSTEMS		N/A
7.1	General		N/A
7.2	Protection of cable distribution system service persons, and users of other equipment connected to the system, from hazardous voltages in the equipment	The EUT is not connected to cable distribution system	N/A
7.3	Protection of equipment users from overvoltages on the cable distribution system		N/A
7.4	Insulation between primary circuits and cable distribution systems		N/A
7.4.1	General		N/A
7.4.2	Voltage surge test		N/A
7.4.3	Impulse test		N/A

IEC 60950-1/Am1			
Clause	Requirement + Test	Result - Remark	Verdict
A	ANNEX A, TESTS FOR RESISTANCE TO HEAT AND FIRE		N/A
A.1	Flammability test for fire enclosures of movable equipment having a total mass exceeding 18 kg, and of stationary equipment (see 4.7.3.2)	The EUT is not such equipment	N/A
A.1.1	Samples		—
	Wall thickness (mm)		—
A.1.2	Conditioning of samples; temperature (°C)		N/A
A.1.3	Mounting of samples		N/A
A.1.4	Test flame (see IEC 60695-11-3)		N/A
	Flame A, B, C or D		—
A.1.5	Test procedure		N/A
A.1.6	Compliance criteria		N/A
	Sample 1 burning time (s)		—
	Sample 2 burning time (s)		—
	Sample 3 burning time (s)		—
A.2	Flammability test for fire enclosures of movable equipment having a total mass not exceeding 18 kg, and for material and components located inside fire enclosures (see 4.7.3.2 and 4.7.3.4)		N/A
A.2.1	Samples, material		—
	Wall thickness (mm)		—
A.2.2	Conditioning of samples; temperature (°C)		N/A
A.2.3	Mounting of samples		N/A
A.2.4	Test flame (see IEC 60695-11-4)		N/A
	Flame A, B or C		—
A.2.5	Test procedure		N/A
A.2.6	Compliance criteria		N/A
	Sample 1 burning time (s)		—
	Sample 2 burning time (s)		—
	Sample 3 burning time (s)		—
A.2.7	Alternative test acc. to IEC 60695-11-5, cl. 5 and 9		N/A
	Sample 1 burning time (s)		—
	Sample 2 burning time (s)		—
	Sample 3 burning time (s)		—
A.3	Hot flaming oil test (see 4.6.2)		N/A

IEC 60950-1/Am1			
Clause	Requirement + Test	Result - Remark	Verdict
A.3.1	Mounting of samples		N/A
A.3.2	Test procedure		N/A
A.3.3	Compliance criterion		N/A

B	ANNEX B, MOTOR TESTS UNDER ABNORMAL CONDITIONS (see 4.7.2.2 and 5.3.2)		N/A
B.1	General requirements	No such device within EUT	N/A
	Position		—
	Manufacturer		—
	Type		—
	Rated values		—
B.2	Test conditions		N/A
B.3	Maximum temperatures		N/A
B.4	Running overload test		N/A
B.5	Locked-rotor overload test		N/A
	Test duration (days)		—
	Electric strength test: test voltage (V)		—
B.6	Running overload test for d.c. motors in secondary circuits		N/A
B.6.1	General		N/A
B.6.2	Test procedure		N/A
B.6.3	Alternative test procedure		N/A
B.6.4	Electric strength test; test voltage (V)		N/A
B.7	Locked-rotor overload test for d.c. motors in secondary circuits		N/A
B.7.1	General		N/A
B.7.2	Test procedure		N/A
B.7.3	Alternative test procedure		N/A
B.7.4	Electric strength test; test voltage (V)		N/A
B.8	Test for motors with capacitors		N/A
B.9	Test for three-phase motors		N/A
B.10	Test for series motors		N/A
	Operating voltage (V)		—

IEC 60950-1/Am1			
Clause	Requirement + Test	Result - Remark	Verdict
C	ANNEX C, TRANSFORMERS (see 1.5.4 and 5.3.3)		P
	Position	T1 (see the illustration on table C.2 for physical construction)	—
	Manufacturer	ENG	—
	Type	See appended table 1.5.1	—
	Rated values	Class B	—
	Method of protection	With external overcurrent protection	—
C.1	Overload test	(see appended table 5.3)	P
C.2	Insulation	(see appended table 5.2)	P
	Protection from displacement of windings	The end-turn of each winding is fixed by insulating tape	P
D	ANNEX D, MEASURING INSTRUMENTS FOR TOUCH-CURRENT TESTS (see 5.1.4)		P
D.1	Measuring instrument		P
D.2	Alternative measuring instrument		N/A
E	ANNEX E, TEMPERATURE RISE OF A WINDING (see 1.4.13)		N/A
F	ANNEX F, MEASUREMENT OF CLEARANCES AND CREEPAGE DISTANCES (see 2.10 and Annex G)		P
G	ANNEX G, ALTERNATIVE METHOD FOR DETERMINING MINIMUM CLEARANCES		N/A
G.1	Clearances		N/A
G.1.1	General		N/A
G.1.2	Summary of the procedure for determining minimum clearances		N/A
G.2	Determination of mains transient voltage (V)		N/A
G.2.1	AC mains supply		N/A
G.2.2	Earthed d.c. mains supplies		N/A
G.2.3	Unearthed d.c. mains supplies		N/A
G.2.4	Battery operation		N/A

IEC 60950-1/Am1			
Clause	Requirement + Test	Result - Remark	Verdict
G.3	Determination of telecommunication network transient voltage (V)		N/A
G.4	Determination of required withstand voltage (V)		N/A
G.4.1	Mains transients and internal repetitive peaks		N/A
G.4.2	Transients from telecommunication networks		N/A
G.4.3	Combination of transients		N/A
G.4.4	Transients from cable distribution systems		N/A
G.5	Measurement of transient voltages (V)		N/A
	a) Transients from a mains supply		N/A
	For an a.c. mains supply		N/A
	For a d.c. mains supply		N/A
	b) Transients from a telecommunication network		N/A
G.6	Determination of minimum clearances		N/A
H	ANNEX H, IONIZING RADIATION (see 4.3.13)		N/A
J	ANNEX J, TABLE OF ELECTROCHEMICAL POTENTIALS (see 2.6.5.6)		N/A
	Metal(s) used		—
K	ANNEX K, THERMAL CONTROLS (see 1.5.3 and 5.3.8)		N/A
K.1	Making and breaking capacity		N/A
K.2	Thermostat reliability; operating voltage (V)		N/A
K.3	Thermostat endurance test; operating voltage (V)		N/A
K.4	Temperature limiter endurance; operating voltage (V)		N/A
K.5	Thermal cut-out reliability		N/A
K.6	Stability of operation		N/A
L	ANNEX L, NORMAL LOAD CONDITIONS FOR SOME TYPES OF ELECTRICAL BUSINESS EQUIPMENT (see 1.2.2.1 and 4.5.2)		P
L.1	Typewriters		N/A
L.2	Adding machines and cash registers		N/A
L.3	Erasers		N/A
L.4	Pencil sharpeners		N/A

IEC 60950-1/Am1			
Clause	Requirement + Test	Result - Remark	Verdict
L.5	Duplicators and copy machines		N/A
L.6	Motor-operated files		N/A
L.7	Other business equipment	Maximum normal operation	P
M	ANNEX M, CRITERIA FOR TELEPHONE RINGING SIGNALS (see 2.3.1)		N/A
M.1	Introduction		N/A
M.2	Method A		N/A
M.3	Method B		N/A
M.3.1	Ringling signal		N/A
M.3.1.1	Frequency (Hz)		—
M.3.1.2	Voltage (V)		—
M.3.1.3	Cadence; time (s), voltage (V)		—
M.3.1.4	Single fault current (mA)		—
M.3.2	Tripping device and monitoring voltage		N/A
M.3.2.1	Conditions for use of a tripping device or a monitoring voltage		N/A
M.3.2.2	Tripping device		N/A
M.3.2.3	Monitoring voltage (V)		N/A
N	ANNEX N, IMPULSE TEST GENERATORS (see 1.5.7.2, 1.5.7.3, 2.10.3.9, 6.2.2.1, 7.3.2, 7.4.3 and Clause G.5)		N/A
N.1	ITU-T impulse test generators		N/A
N.2	IEC 60065 impulse test generator		N/A
P	ANNEX P, NORMATIVE REFERENCES		—
Q	ANNEX Q, Voltage dependent resistors (VDRs) (see 1.5.9.1)		P
	a) Preferred climatic categories	Approved varistor is used	P
	b) Maximum continuous voltage	See appended table 1.5.1	P
	c) Pulse current	6 kV/3kA, 1.2/50 μ s for voltage and 8/20 μ s for current	P

IEC 60950-1/Am1			
Clause	Requirement + Test	Result - Remark	Verdict
R	ANNEX R, EXAMPLES OF REQUIREMENTS FOR QUALITY CONTROL PROGRAMMES		N/A
R.1	Minimum separation distances for unpopulated coated printed boards (see 2.10.6.2)		N/A
R.2	Reduced clearances (see 2.10.3)		N/A
S	ANNEX S, PROCEDURE FOR IMPULSE TESTING (see 6.2.2.3)		N/A
S.1	Test equipment		N/A
S.2	Test procedure		N/A
S.3	Examples of waveforms during impulse testing		N/A
T	ANNEX T, GUIDANCE ON PROTECTION AGAINST INGRESS OF WATER (see 1.1.2)		N/A
U	ANNEX U, INSULATED WINDING WIRES FOR USE WITHOUT INTERLEAVED INSULATION (see 2.10.5.4)		P
		Used of three layers of extruded insulation wire and passes the tests of annex U	—
V	ANNEX V, AC POWER DISTRIBUTION SYSTEMS (see 1.6.1)		P
V.1	Introduction		P
V.2	TN power distribution systems		P
W	ANNEX W, SUMMATION OF TOUCH CURRENTS		N/A
W.1	Touch current from electronic circuits		N/A
W.1.1	Floating circuits		N/A
W.1.2	Earthed circuits		N/A
W.2	Interconnection of several equipments		N/A
W.2.1	Isolation		N/A
W.2.2	Common return, isolated from earth		N/A
W.2.3	Common return, connected to protective earth		N/A
X	ANNEX X, MAXIMUM HEATING EFFECT IN TRANSFORMER TESTS (see clause C.1)		N/A

IEC 60950-1/Am1			
Clause	Requirement + Test	Result - Remark	Verdict
X.1	Determination of maximum input current		N/A
X.2	Overload test procedure		N/A
Y	ANNEX Y, ULTRAVIOLET LIGHT CONDITIONING TEST (see 4.3.13.3)		N/A
Y.1	Test apparatus		N/A
Y.2	Mounting of test samples		N/A
Y.3	Carbon-arc light-exposure apparatus		N/A
Y.4	Xenon-arc light exposure apparatus		N/A
Z	ANNEX Z, OVERVOLTAGE CATEGORIES (see 2.10.3.2 and Clause G.2)		N/A
AA	ANNEX AA, MANDREL TEST (see 2.10.5.8)		N/A
BB	ANNEX BB, CHANGES IN THE SECOND EDITION		—
CC	ANNEX CC, Evaluation of integrated circuit (IC) current limiters		N/A
CC.1	General	No such device within the EUT	N/A
CC.2	Test program 1.....		N/A
CC.3	Test program 2.....		N/A
DD	ANNEX DD, Requirements for the mounting means of rack-mounted equipment		N/A
DD.1	General	The EUT is not such equipment	N/A
DD.2	Mechanical strength test, variable N.....		N/A
DD.3	Mechanical strength test, 250N, including end stops.....		N/A
DD.4	Compliance.....		N/A
EE	ANNEX EE, Household and home/office document/media shredders		N/A
EE.1	General	The EUT is not such equipment	N/A
EE.2	Markings and instructions		N/A
	Use of markings or symbols.....		N/A
	Information of user instructions, maintenance and/or servicing instructions.....		N/A

IEC 60950-1/Am1			
Clause	Requirement + Test	Result - Remark	Verdict
EE.3	Inadvertent reactivation test.....:		N/A
EE.4	Disconnection of power to hazardous moving parts:		N/A
	Use of markings or symbols.....:		N/A
EE.5	Protection against hazardous moving parts		N/A
	Test with test finger (Figure 2A):		N/A
	Test with wedge probe (Figure EE1 and EE2):		N/A

IEC 60950-1/Am1			
Clause	Requirement + Test	Result - Remark	Verdict

1.5.1	TABLE: List of critical components					P
Object/part No.	Manufacturer/ trademark	Type/model	Technical data	Standard (Edition / year)	Mark(s) of conformity ¹⁾	
Appliance Inlet	Tecx-Unions Technology Corp	SO-222 Series	2.5 A, 250 V, 70 °C	IEC/EN 60320-1	VDE	
Alt.	various	various	2.5 A, 250 V, 70 °C	IEC/EN 60320-1	S, VDE or other EU certification marks	
Fuse (F1)	Conquer	MST	T1A, 250 V, LBC	IEC/EN 60127-3	VDE	
Alt.	various	various	T1A, 250 V, LBC	IEC/EN 60127-3	S, VDE or other EU certification marks	
Varistor (ZNR1) (Optional)	Centra Science Corp	CNR-14V511K, CNR-14D471K,	Min. 300 Vac, 14 Ø	IEC 61051-2, CECC 42 200 UL 1449	VDE, UL	
Alt.	Centra Science Corp	CNR-10D471K, CNR-10V471K, CNRV-10D471K	Min. 300 Vac, 10 Ø	IEC 61051-2, CECC 42 200 UL 1449	VDE, UL	
Alt.	Thinking	TVR14471, TVR14471-K, TVR14511-K	Min. 300 Vac, 14 Ø	IEC 61051-2, CECC 42 200 UL 1449	VDE, UL	
Alt.	Thinking	TVR10471-D, TVR10471-K, TVR10511-K, TVR10471-V	Min. 300 Vac, 10 Ø	IEC 61051-2, CECC 42 200 UL 1449	VDE, UL	
Alt.	Joyin Co., Ltd.	14N471K, 14N511K, 14S511K	Min. 300 Vac, 14 Ø	IEC 61051-2, CECC 42 200 UL 1449	VDE, UL	
Alt.	Joyin Co., Ltd.	10N511K, 10N471K, 10S471K	Min. 300 Vac, 10 Ø	IEC 61051-2, CECC 42 200 UL 1449	VDE, UL	
Alt.	Ceramate Technical Co., Ltd.	GNR14D471K, GNR14D511K,	Min. 300 Vac, 14 Ø	IEC 61051-2, CECC 42 200 UL 1449	VDE, UL	

IEC 60950-1/Am1			
Clause	Requirement + Test	Result - Remark	Verdict

1.5.1	TABLE: List of critical components					P
Object/part No.	Manufacturer/ trademark	Type/model	Technical data	Standard (Edition / year)	Mark(s) of conformity ¹⁾	
Alt.	Ceramate Technical Co., Ltd.	GNR10D471K	Min. 300 Vac, 10 Ø	IEC 61051-2, CECC 42 200 UL 1449	VDE, UL	
Alt.	Ceramate Technical Co., Ltd.	GNR10D471K	Min. 300 Vac, 10 Ø	IEC 61051-2, CECC 42 200 UL 1449	VDE, UL	
Alt.	Meritek Electronics Corp.	MVR14D471K, MVR14D511K	Min. 300 Vac, 14 Ø	IEC 61051-2, CECC 42 200 UL 1449	VDE, UL	
Alt.	Success Electronics CO., LTD.	SVR10D471K, SVR10D511K	Min. 300 Vac, 10 Ø	IEC 61051-2, CECC 42 200 UL 1449	VDE, UL	
Alt.	Success Electronics CO., LTD.	SVR14D471K, SVR14D511K	Min. 300 Vac, 14 Ø	IEC 61051-2, CECC 42 200 UL 1449	VDE, UL	
X-Capacitor (CX1)	Ultra Tech	HQX	Max. 0.22 uF, Min. 275 V, 100 °C, X2	IEC 60384-14, 2nd edition	VDE	
Alt.	various	various	Max. 0.22 µF, Min. 250 V, 100 °C, X2	IEC 60384-14, 2nd edition	S, VDE or other EU certification marks	
Bleeding resistor (R1, R2)	various	various	Max.1.5 M ohm, 1/4 W, two in series after fuse	Applicable parts of IEC 60950-1	Tested in appliance	
C. M. choke (NF1) (Optional)	ENG	NF00030	Min. 130 °C	Applicable parts of IEC 60950-1	Tested in appliance	
Y-Capacitor (CY1)	WALSIN	AH	Max. 1000 pF, Min. 250 V, 125 °C, Y1	IEC 60384-14, 2nd edition	VDE	
Alt.	various	various	Max. 1000 pF, Min. 250 V, 125 °C, Y1	IEC 60384-14, 2nd edition	S, VDE or other EU certification marks	

IEC 60950-1/Am1			
Clause	Requirement + Test	Result - Remark	Verdict

1.5.1	TABLE: List of critical components					P
Object/part No.	Manufacturer/ trademark	Type/model	Technical data	Standard (Edition / year)	Mark(s) of conformity ¹⁾	
Y-Capacitor (CY2)	WALSIN	AH	Max. 100 pF, Min. 250 V, 125 °C, Y1	IEC 60384-14, 2nd edition	VDE	
Alt.	various	various	Max. 100 pF, Min. 250 V, 125 °C, Y1	IEC 60384-14, 2nd edition	S, VDE or other EU certification marks	
Bridge diode (D1, D2, D3, D4)	various	various	Min. 1 A, min. 600 V	Applicable parts of IEC 60950-1	Tested in appliance	
Ripple capacitor (C1)	various	various	33 µF, Min. 400 V, 105 °C	Applicable parts of IEC 60950-1	Tested in appliance	
MOSFET (Q1)	various	various	Min. 3.5 A, 600 V	Applicable parts of IEC 60950-1	Tested in appliance	
Optocoupler (PC1)	Lite-on	LTV-817	Dtl ≥ 0.4 mm; Int. cr > 4 mm; Ext. cr = 8 mm	IEC 60950-1, VDE 0884	VDE, FI	
Alt.	Everlight	EL817	Dtl = 0.5 mm; Int. cr = 6.0 mm; Ext. cr = 7.7 mm	IEC 60950-1, VDE 0884	VDE, FI	
Alt.	COSMO	K1010	Dti = 0.5 mm; Int. cr = 5.3 mm; Ext. cr = 8.0 mm	IEC 60950-1, VDE 0884	VDE, FI	
Secondary diode (D8) (for models 3A-186DA05, 3A-186DA05A, 3A-186DA06	various	various	Min. 20 A, 45 V	Applicable parts of IEC 60950-1	Tested in appliance	
Secondary diode (D8) (for models 3A-186DA12, 3A-186DA15)	various	various	Min. 5 A, 100 V	Applicable parts of IEC 60950-1	Tested in appliance	

IEC 60950-1/Am1			
Clause	Requirement + Test	Result - Remark	Verdict

1.5.1	TABLE: List of critical components					P
Object/part No.	Manufacturer/ trademark	Type/model	Technical data	Standard (Edition / year)	Mark(s) of conformity ¹⁾	
Output cord (for models 3A-186DA05, 3A-186DA05A, 3A-186DA06)	various	various	Min. 300 V, VW-1, 18 AWG × 2C, 80 °C	Applicable parts of IEC 60950-1, UL 758	UL recognized	
Output cord (for models 3A-186DA12, 3A-186DA15)	various	various	Min. 300 V, VW-1, 20 AWG × 2C, 80 °C	Applicable parts of IEC 60950-1, UL 758	UL recognized	
Transformer (T1):						
Transformer (for models 3A-186DA05, 3A-186DA05A, 3A-186DA06)	ENG	XF00577	Class B	Applicable parts of IEC 60950-1	Tested in appliance	
Transformer (for models 3A-186DA12, 3A-186DA15)	ENG	XF00578	Class B	Applicable parts of IEC 60950-1	Tested in appliance	
Primary magnet wires	Pacific Electric	UEWN/U, UEWS/U	Min. 130 °C	Applicable parts of IEC 60950-1	Tested in appliance	
Alt.	Jung Shing	UEW-4, UEY-2	Min. 130 °C	Applicable parts of IEC 60950-1	Tested in appliance	
Secondary TIW	Great Leoflon	TRW (B)	Min. 130 °C	IEC60950-1	VDE	
Plastic Material List:						
Enclosure	Sabic Innovative Plastics	SE1X	Min. V-1, min. 1.65 mm thick, 105 °C	Applicable parts of IEC 60950, UL 94	UL Recognized	
Bobbin of T1	Chang Chun	T375J	V-0, 150 °C	Applicable parts of IEC 60950-1, UL 94	UL recognized	
Alt.	Sumitomo Bakelite	PM-9820	V-0, 150 °C	Applicable parts of IEC 60950-1, UL 94	UL recognized	

IEC 60950-1/Am1			
Clause	Requirement + Test	Result - Remark	Verdict

1.5.1	TABLE: List of critical components					P
Object/part No.	Manufacturer/ trademark	Type/model	Technical data	Standard (Edition / year)	Mark(s) of conformity ¹⁾	
Insulating tape	3M	1350F(#), 1350T-1	Min. 130 °C	Applicable parts of IEC 60950-1, UL 510	UL recognized	
Alt.	Bondtec Pacific	370S	Min. 130 °C	Applicable parts of IEC 60950-1, UL 510	UL recognized	
PCB	Techni Technology Ltd	T2B	Min. V-1, 130 °C	Applicable parts of IEC 60950-1, UL 94, UL 796	UL recognized	
Alt.	various	various	Min. V-1, 130 °C	Applicable parts of IEC 60950-1, UL 94, UL 796	UL recognized	

Supplementary information:

Note:

- 1) An asterisk indicates a mark which assures the agreed level of surveillance.
- 2) All the plastic material mentioned are checked and found to be acceptable for using in this product.
Checking date: Same as this report issued data, see also page 1.
- 3) A power supply cord set, complying with national requirements, shall be provided when marketing in the specified countries.

IEC 60950-1/Am1			
Clause	Requirement + Test	Result - Remark	Verdict
1.5.1	TABLE: Opto Electronic Devices		P
Manufacturer : See appended table 1.5.1 for details.			
Type..... : See appended table 1.5.1 for details.			
Separately tested..... : Tested by VDE			
Bridging insulation : Reinforced insulation			
External creepage distance : See appended table 1.5.1 for details.			
Internal creepage distance : See appended table 1.5.1 for details.			
Distance through insulation : See appended table 1.5.1 for details.			
Tested under the following conditions : RI			
Input..... :			
Output..... :			
supplementary information			

IEC 60950-1/Am1			
Clause	Requirement + Test	Result - Remark	Verdict

1.6.2	TABLE: Electrical data (in normal conditions)	P
--------------	--	----------

U (V)	I (mA)	I _{rated} (A)	P (W)	Fuse #	I _{fuse} (mA)	Condition/status
-------	--------	------------------------	-------	--------	------------------------	------------------

Tested on model: 3A-186DA05

90V/50Hz	421	—	23.2	F1	421	Maximum normal load
90V/60Hz	415	—	23.1	F1	415	Maximum normal load
100V/50Hz	379	0.5	22.9	F1	379	Maximum normal load
100V/60Hz	373	0.5	22.8	F1	373	Maximum normal load
240V/50Hz	178	0.5	22.3	F1	178	Maximum normal load
240V/60Hz	170	0.5	22.3	F1	170	Maximum normal load
254V/50Hz	169	—	22.2	F1	169	Maximum normal load
254V/60Hz	161	—	22.2	F1	161	Maximum normal load
264V/50Hz	164	—	22.2	F1	164	Maximum normal load
264V/60Hz	156	—	22.2	F1	156	Maximum normal load

Tested on model: 3A-186DA15

90V/50Hz	395	--	21.5	F1	395	Maximum normal load
90V/60Hz	388	--	21.5	F1	388	Maximum normal load
100V/50Hz	359	0.5	21.3	F1	359	Maximum normal load
100V/60Hz	350	0.5	21.3	F1	350	Maximum normal load
240V/50Hz	170	0.5	21.1	F1	170	Maximum normal load
240V/60Hz	162	0.5	21.1	F1	162	Maximum normal load
254V/50Hz	162	—	21.2	F1	162	Maximum normal load
254V/60Hz	155	—	21.2	F1	155	Maximum normal load
264V/50Hz	157	--	21.3	F1	157	Maximum normal load
264V/60Hz	150	--	21.3	F1	150	Maximum normal load

Supplementary information:
 The measured input current at rated voltage shall be ≤ 110 % of rated current.

IEC 60950-1/Am1				
Clause	Requirement + Test	Result - Remark		Verdict
2.1.1.5 c) 1)	TABLE: max. V, A, VA test			P
Voltage (rated) (V)	Current (rated) (A)	Voltage (max.) (V)	Current (max.) (A)	VA (max.) (VA)
Tested on model: 3A-186DA05				
5	3.6	5.16	5.09	23.92
Tested on model: 3A-186DA15				
15	1.2	15.16	1.81	26.82
supplementary information:				

2.1.1.5 c) 2)	TABLE: stored energy			N/A
Capacitance C (μF)	Voltage U (V)		Energy E (J)	
supplementary information:				

IEC 60950-1/Am1			
Clause	Requirement + Test	Result - Remark	Verdict

2.2	TABLE: evaluation of voltage limiting components in SELV circuits			P
Component (measured between)	max. voltage (V) (normal operation)		Voltage Limiting Components	
	V peak	V d.c.		
Tested on model: 3A-186DA05				
T1 Pin A to Pin B	23.8	--	--	
Tested on model: 3A-186DA15				
T1 Pin A to Pin B	48.0	--	--	
T1 Pin A to Pin B after D8	--	16.8	D8	
Fault test performed on voltage limiting components	Voltage measured (V) in SELV circuits (V peak or V d.c.)			
Tested on model: 3A-186DA05				
D8 shorted	0 Vdc (shutdown)			
Tested on model: 3A-186DA15				
D8 shorted	0 Vdc (shutdown)			
supplementary information:				
Supplementary information:				
Test voltage: 264 Vac, 60 Hz				

2.5	TABLE: limited power sources			P
Model: 3A-186DA05				
Circuit output tested: V (+) – V (-)				
Measured Uoc (V) with all load circuits disconnected:	5.16 Vdc			
	I _{sc} (A)		VA	
	Meas.	Limit	Meas.	Limit
Normal condition	5.09	≤ 8.0 A	23.9	≤ 100 VA
Circuit output tested: V (+) – GND				
Measured Uoc (V) with all load circuits disconnected:	5.19 Vdc			
	I _{sc} (A)		VA	
	Meas.	Limit	Meas.	Limit
Single fault condition (L1 short)	5.14	≤ 8.0 A	24.5	≤ 100 VA

IEC 60950-1/Am1				
Clause	Requirement + Test	Result - Remark		Verdict
2.5	TABLE: limited power sources			P
Circuit output tested: V (+) – GND				
Measured Uoc (V) with all load circuits disconnected:		See the note below		
		I _{sc} (A)		VA
		Meas.	Limit	Meas. Limit
Single fault condition		--	≤ 8.0 A	-- ≤ 100 VA
Model: 3A-186DA15				
Circuit output tested: V (+) – V (-)				
Measured Uoc (V) with all load circuits disconnected:		15.16 Vdc		
		I _{sc} (A)		VA
		Meas.	Limit	Meas. Limit
Normal condition		1.81	≤ 8.0 A	26.8 ≤ 100 VA
Circuit output tested: V (+) – GND				
Measured Uoc (V) with all load circuits disconnected:		15.19 Vdc		
		I _{sc} (A)		VA
		Meas.	Limit	Meas. Limit
Single fault condition (L1 short)		1.85	≤ 8.0 A	24.8 ≤ 100 VA
Circuit output tested: V (+) – GND				
Measured Uoc (V) with all load circuits disconnected:		See the note below		
		I _{sc} (A)		VA
		Meas.	Limit	Meas. Limit
Single fault condition		--	≤ 8.0 A	-- ≤ 100 VA
supplementary information:				
Note:				
For all model, the other single fault conditions are relate to the below:				
Measured result unit damage under the single fault condition of R10 short-circuited.				
Measured result shut down under the single fault condition of PC1 (pin 1-2) short-circuited.				
Measured result shut down under the single fault condition of PC1 (pin 3-4) opened-circuited.				
Measured result shut down under the single fault condition of PC1 (pin 1) opened-circuited.				
Measured result shut down under the single fault condition of PC1 (pin 3) opened-circuited.				

IEC 60950-1/Am1			
Clause	Requirement + Test	Result - Remark	Verdict

2.10.2	Table: working voltage measurement			P
Location	RMS voltage (V)	Peak voltage (V)	Comments	
Tested on model: 3A-186DA15				
T1 pin 1 to pin A	254	468	--	
T1 pin 1 to pin B	266	472	--	
T1 pin 1 to pin 6	268	472	--	
T1 pin 2 to pin A	212	392	--	
T1 pin 2 to pin B	210	348	--	
T1 pin 2 to pin 6	207	352	--	
T1 pin 3 to pin A	213	360	--	
T1 pin 3 to pin B	216	408	--	
T1 pin 3 to pin 6	213	404	--	
T1 pin 4 to pin A	215	368	--	
T1 pin 4 to pin B	213	348	--	
T1 pin 4 to pin 6	211	356	--	
PC1 pin 3 to pin 1	222	368	--	
PC1 pin 3 to pin 2	220	364	--	
PC1 pin 4 to pin 1	221	364	--	
PC1 pin 4 to pin 2	220	364	--	
CY1 primary pin to secondary pin	212	352	--	
CY2 primary pin to secondary pin	238	352	--	
Tested on model: 3A-186DA05				
T1 pin 1 to pin A	258	488	--	
T1 pin 1 to pin B	263	484	--	
T1 pin 1 to pin 6	263	484	--	
T1 pin 2 to pin A	211	376	--	
T1 pin 2 to pin B	209	356	--	
T1 pin 2 to pin 6	209	356	--	
T1 pin 3 to pin A	213	380	--	
T1 pin 3 to pin B	213	400	--	

IEC 60950-1/Am1			
Clause	Requirement + Test	Result - Remark	Verdict

2.10.2	Table: working voltage measurement			P
Location	RMS voltage (V)	Peak voltage (V)	Comments	
T1 pin 3 to pin 6	213	400	--	
T1 pin 4 to pin A	210	360	--	
T1 pin 4 to pin B	211	356	--	
T1 pin 4 to pin 6	210	356	--	
PC1 pin 3 to pin 1	213	360	--	
PC1 pin 3 to pin 2	212	360	--	
PC1 pin 4 to pin 1	213	360	--	
PC1 pin 4 to pin 2	212	360	--	
CY1 primary pin to secondary pin	210	360	--	
CY2 primary pin to secondary pin	238	352	--	
supplementary information:				
1. Test voltage: 240 Vac, 60 V				
2. Bold texts indicate the highest Vrms and Vpeak				

2.10.3 and 2.10.4	TABLE: Clearance and creepage distance measurements						P
Clearance (cl) and creepage distance (cr) at/of/between:	U peak (V)	U r.m.s. (V)	Required cl (mm)	cl (mm)	Required cr (mm)	cr (mm)	
On PCB solder side:							
Line and Neutral before and after current fuse (F1) (FI)	340	240	1.5	9.8	2.5	9.8	
Two ends of the current fuse (F1) (FI)	340	240	1.5	2.7	2.5	2.7	
Primary and secondary (two sides of CY1) (RI)	360	240	4.0	6.2	5.0	5.2	
Primary and secondary (two sides of CY2) (RI)	352	240	4.0	5.4	5.0	5.4	
Primary and secondary (two sides of PC1) (RI)	368	240	4.0	5.5	5.0	5.5	
Primary to user accessible parts (RI)	340	240	4.0	5.8	5.0	5.8	

IEC 60950-1/Am1						
Clause	Requirement + Test	Result - Remark				Verdict
2.10.3 and 2.10.4	TABLE: Clearance and creepage distance measurements					P
Clearance (cl) and creepage distance (cr) at/of/between:	U peak (V)	U r.m.s. (V)	Required cl (mm)	cl (mm)	Required cr (mm)	cr (mm)
Primary and secondary (two sides between C4 and IC1) (RI)	340	240	4.0	6.0	5.0	6.0
On PCB component side:						
Primary to user accessible parts (RI)	340	240	4.0	5.8	5.0	5.8
Primary and secondary (two sides between C4 and IC1) (RI)	340	240	4.0	6.0	5.0	6.0
Transformer (T1):						
Primary traces to secondary traces on PCB solder side (RI)	488	268	4.2	6.6	5.4	6.6
Secondary components (CY1) to core (RI)	488	268	4.2	5.8	5.4	5.8
Supplementary information:						
1) FI: insulation; BI: Basic insulation; SI: Supplementary insulation; RI: Reinforced insulation. 2) A force of 10 N is applied to the internal components and 30 N is applied to the enclosure when measuring the distances. 3) The core of transformer (T1) is considered as primary winding, the TIW is used in secondary winding of transformer (T1).						

IEC 60950-1/Am1			
Clause	Requirement + Test	Result - Remark	Verdict

2.10.5	TABLE: Distance through insulation measurements					P
Distance through insulation (DTI) at/of:	U peak (V)	U rms (V)	Test voltage (V)	Required DTI (mm)	DTI (mm)	
RI: Optocoupler (PC1)	368	240	3000 Vac	0.4	0.4	
RI: Enclosure: inner/outer	340	240	3000 Vac	0.4	1.65	
thin sheet material at/of:	U _p (V)	U rms (V)	test voltage (V)	required layer(s)	layer(s)	
Insulating tape around the outer side ²⁾ of transformer (T1) (RI)	488	268	3000 Vac / 1 layer	2	2	
Supplementary information:						
1. FI: Functional insulation; BI: Basic insulation; SI: Supplementary insulation; RI: Reinforced insulation.						
2. The core of transformer (T1) is considered as primary winding.						

IEC 60950-1/Am1										
Clause	Requirement + Test			Result - Remark				Verdict		
4.3.8	TABLE: Batteries								N/A	
The tests of 4.3.8 are applicable only when appropriate battery data is not available								—		
Is it possible to install the battery in a reverse polarity position?								—		
	Non-rechargeable batteries			Rechargeable batteries						
	Discharging		Un-intentional charging	Charging		Discharging		Reversed charging		
	Meas. current	Manuf. Specs.		Meas. current	Manuf. Specs.	Meas. current	Manuf. Specs.	Meas. current	Manuf. Specs.	
Max. current during normal condition	—	—	—	—	—	—	—	—	—	
Max. current during fault condition	—	—	—	—	—	—	—	—	—	
Test results:										
- Chemical leaks								—		
- Explosion of the battery								—		
- Emission of flame or expulsion of molten metal								—		
- Electric strength tests of equipment after completion of tests								—		
Supplementary information:										

IEC 60950-1/Am1			
Clause	Requirement + Test	Result - Remark	Verdict

4.3.8	TABLE: Batteries		N/A
--------------	-------------------------	--	-----

Battery category: Manufacturer.....: Type / model: Voltage.....: Capacity: Tested and Certified by (incl. Ref. No.).....: Circuit protection diagram: 			
---	--	--	--

MARKINGS AND INSTRUCTIONS (1.7.12, 1.7.15)	
Location of replaceable battery	
Language(s)	
Close to the battery	
In the servicing instructions	
In the operating instructions	

IEC 60950-1/Am1						
Clause	Requirement + Test	Result - Remark				Verdict
4.5	TABLE: maximum temperatures					P
	test voltage (V)	90Vac	264Vac	90Vac	264Vac	—
	t _{amb1} (°C)	40	40	40	40	—
	t _{amb2} (°C)	40	40	40	40	—
maximum temperature T of part/at::		T (°C)				allowed T _{max} (°C)
Test position:		Label up		Label down		--
T1 coil		105.7	97.6	101.5	91.5	110 (120-10, B)
T1 core		104.3	96.9	99.2	91.5	110 (120-10, B)
NF1 coil		97.0	75.5	93.6	68.4	120 (130-10)
CX1 body near NF1		70.5	60.3	69.5	55.7	100
L1 coil		86.0	81.6	79.6	76.0	120 (130-10)
C1 body		84.9	71.1	82.2	67.6	105
AC Inlet		50.9	48.0	51.3	45.4	70
C8 body		95.6	89.7	87.4	82.8	105
ZNR body		76.3	62.9	71.9	55.8	130, PCB
PCB near Q1		101.5	87.1	94.6	82.5	130, PCB
CY1 body		99.6	90.6	93.0	81.6	125
CY2 body		89.0	80.2	81.0	70.4	125
PC1 body		83.6	76.1	72.8	69.7	100
PCB near D8		107.0	101.4	96.5	93.2	130, PCB
D1 body near D2		107.1	84.9	102.8	76.5	130, PCB
D3 body near D4		102.8	78.7	97.3	70.6	130, PCB
Output wire		76.8	73.5	68.6	67.5	80
Enclosure inside above T1		80.7	75.3	67.5	67.0	For stress relief
Enclosure outside above T1		73.8	69.4	56.7	58.7	95
Note:						
Max. Operation ambient is considered as 40 °C which declared by the manufacturer.						
Tested on model: 3A-186DA05 .						

IEC 60950-1/Am1						
Clause	Requirement + Test	Result - Remark				Verdict
4.5	TABLE: maximum temperatures					P
	test voltage (V)	90Vac	264Vac	90Vac	264Vac	—
	t _{amb1} (°C)	40	40	40	40	—
	t _{amb2} (°C)	40	40	40	40	—
maximum temperature T of part/at::		T (°C)				allowed T _{max} (°C)
Test position:		Label up		Label down		
T1 coil		101.3	95.5	100.3	98.6	110 (120-10, B)
T1 core		95.5	91.4	93.9	94.2	110 (120-10, B)
NF1 coil		95.9	75.7	95.7	77.4	120 (130-10)
CX1 body near NF1		72.6	62.4	73.5	64.3	100
L1 coil		68.5	65.8	66.0	66.3	120 (130-10)
C1 body		87.4	75.5	87.9	76.8	105
AC Inlet		56.3	51.4	56.4	52.1	70
C8 body		81.3	78.5	78.8	80.1	105
ZNR body		81.2	65.8	79.8	66.7	130, PCB
PCB near Q1		105.9	95.1	106.2	96.5	130, PCB
CY1 body		91.5	85.2	88.8	86.3	125
CY2 body		82.4	75.1	80.3	76.6	125
PC1 body		84.1	78.5	81.0	78.2	100
PCB near D8		107.6	105.2	103.9	105.9	130, PCB
D1 body near D2		104.5	85.0	104.7	86.1	130, PCB
D3 body near D4		100.2	80.2	98.7	80.0	130, PCB
Output wire		69.2	66.6	66.6	67.3	80
Enclosure inside above T1		82.3	78.5	79.0	78.6	For stress relief
Enclosure outside above T1		72.5	69.5	68.8	68.8	95
Note:						
Max. Operation ambient is considered as 40 °C which declared by the manufacturer.						
Tested on model: 3A-186DA15 .						

IEC 60950-1/Am1			
Clause	Requirement + Test	Result - Remark	Verdict

4.5.5	TABLE: Ball pressure test of thermoplastic parts		P
	Allowed impression diameter (mm)	≤ 2 mm	—
Part	Test temperature (°C)	Impression diameter (mm)	
PCB	125	1.0	
Bobbin of T1 for material type T375J	125	1.4	
Bobbin of T1 for material type PM-9820	125	1.4	
Supplementary information:			

4.7	TABLE: Resistance to fire				P
Part	Manufacturer of material	Type of material	Thickness (mm)	Flammability class	Evidence
Enclosure	SABIC	SE1X	Min. 1.65 mm	V-1	UL Recognized
Bobbin of T1	Chang Chun	T375J	Min. 0.8 mm	V-0	UL Recognized
Alt.	Sumitomo Bakelite	PM-9820	Min. 0.8 mm	V-0	UL Recognized
PCB	Techni	T2B	Min. 1.5 mm	Min. V-0	UL Recognized
Alt.	various	various	Min. 1.5 mm	Min. V-1	UL Recognized
Supplementary information: --					

IEC 60950-1/Am1			
Clause	Requirement + Test	Result - Remark	Verdict

5.1	TABLE: touch current measurement		P
------------	---	--	----------

Measured between:	Measured (mA)	Limit (mA)	Comments/conditions
L/N and secondary	0.091	0.25	—
L/N and unearthed enclosure covered with metal foil	0.02	0.25	—
supplementary information:			
1. Test voltage: 264 Vac, 60 Hz			
2. Y-capacitor(s) used in the equipment: CY1: 1000 pF, CY2: 100 pF			

5.2	TABLE: Electric strength tests, impulse tests and voltage surge tests		P
------------	--	--	----------

Test voltage applied between:	Voltage shape (AC, DC, impulse, surge)	Test voltage (V)	Breakdown Yes / No
-------------------------------	--	------------------	--------------------

Electric strength test:			
RI: L/N and secondary circuits	DC	4242	No
RI: L/N and plastic enclosure covered with metal foil	AC	3000	No
RI: Transformer: primary and secondary	AC	3000	No
BI: Transformer: secondary and core	AC	3000	No
FI: Line and Neutral after current fuse (F1) opened	AC	1500	No

Supplementary information:			
1. FI: Functional insulation; BI: Basic insulation; SI: Supplementary insulation; RI: Reinforced insulation.			
2. Test voltage a.c. / d.c.			
3. The core of transformer (T1) is considered as primary winding.			
4. Test on Models 3A-186DA05, 3A-186DA15.			

IEC 60950-1/Am1						
Clause	Requirement + Test				Result - Remark	Verdict
5.3	TABLE: Fault condition tests					P
	Ambient temperature (°C)				25, if no else specified	—
	Power source for EUT: Manufacturer, model/type, output rating				See appended table 1.5.1	—
Component No.	Fault	Supply voltage (V)	Test time	Fuse #	Fuse current (A)	Observation
Model: 3A-186DA05						
C1	S	264	<1 sec	F1	> 2.1	Observation: F1 opened; No hazards Damaged: — Temp: — Max. Voltage: —
D1	S	264	<1 sec	F1	> 2.1	Observation: F1 opened; No hazards Damaged: — Temp: — Max. Voltage: —
D8	S	264	10 min	F1	0.032	Observation: Unit shutdown; No hazards Damaged: — Temp: — Max. Voltage: —
ZD2	S	264	10 min	F1	0.043	Observation: Unit shutdown; No hazards Damaged: — Temp: — Max. Voltage: —
R10	S	264	<1 sec	F1	> 2.1	Observation: F1 opened; No hazards Damaged: — Temp: — Max. Voltage: —
U1 Pin 1-2	S	264	10 min	F1	0.018	Observation: Unit shutdown; No hazards Damaged: — Temp: — Max. Voltage: —
U1 Pin 1-5	S	264	10 min	F1	0.018	Observation: Unit shutdown; No hazards Damaged: — Temp: — Max. Voltage: —

IEC 60950-1/Am1			
Clause	Requirement + Test	Result - Remark	Verdict

5.3	TABLE: Fault condition tests (continued)						P
Component No.	Fault	Supply voltage (V)	Test time	Fuse #	Fuse current (A)	Observation	
U1 Pin 2-5	S	264	10 min	F1	0.018	Observation: Unit shutdown; No hazards Damaged: — Temp: — Max. Voltage: —	
U1 Pin 4-5	S	264	10 min	F1	0.018	Observation: Unit shutdown; No hazards Damaged: — Temp: — Max. Voltage: —	
U1 Pin 6-5	S	264	10 min	F1	0.018	Observation: Unit shutdown; No hazards Damaged: — Temp: — Max. Voltage: —	
PC1 Pin 1-2	S	264	10 min	F1	0.018	Observation: Unit shutdown; No hazards Damaged: — Temp: — Max. Voltage: —	
PC1 Pin 3-4	S	264	10 min	F1	0.018	Observation: Unit shutdown; No hazards Damaged: — Temp: — Max. Voltage: —	
PC1 Pin 1	O	264	10 min	F1	0.018	Observation: Unit shutdown; No hazards Damaged: — Temp: — Max. Voltage: —	
PC1 Pin 3	O	264	10 min	F1	0.018	Observation: Unit shutdown; No hazards Damaged: — Temp: — Max. Voltage: —	
Q1 (G-D)	S	264	<1 sec	F1	> 2.1	Observation: F1 opened; No hazards Damaged: Q1, R10 Temp: — Max. Voltage: —	

IEC 60950-1/Am1			
Clause	Requirement + Test	Result - Remark	Verdict

5.3	TABLE: Fault condition tests (continued)					P
Component No.	Fault	Supply voltage (V)	Test time	Fuse #	Fuse current (A)	Observation
Q1 (D-S)	S	264	<1 sec	F1	> 2.1	Observation: F1 opened; No hazards Damaged: Q1, R10 Temp: — Max. Voltage: —
Q1 (G-S)	S	264	10 min	F1	0.018	Observation: Unit shutdown; No hazards Damaged: — Temp: — Max. Voltage: —
T1 Pin A-B	S	264	10 min	F1	0.033	Observation: Unit shutdown; No hazards Damaged: — Temp: — Max. Voltage: —
T1 Pin 1-2	S	264	10 min	F1	0.045	Observation: Unit shutdown; No hazards Damaged: — Temp: — Max. Voltage: —
T1 Pin 3-4	S	264	10 min	F1	0.034	Observation: Unit shutdown; No hazards Damaged: — Temp: — Max. Voltage: —
Output	S	264	10 min	F1	0.019	Observation: Unit shutdown; No hazards Damaged: — Temp: — Max. Voltage: —
Output	O/L	264	Steady state	F1	0.214	Total testing duration: 9 hours. Normal operation at output overload to max. 4.4 A. No hazards. Damage: — Temp: T1= 107.3°C, PC1= 76.5°C, Ambient= 24.4°C Max. Voltage: —

IEC 60950-1/Am1			
Clause	Requirement + Test	Result - Remark	Verdict

5.3	TABLE: Fault condition tests (continued)					P
Component No.	Fault	Supply voltage (V)	Test time	Fuse #	Fuse current (A)	Observation
T1 pin A-B (after D8)	O/L	264	Steady state	F1	0.225	Total testing duration: 9 hours. Normal operation at output overload to max. 4.5 A. No hazards. Damage: — Temp: T1= 104.1°C, PC1= 75.3°C, Ambient= 25.5°C Max. Voltage: —
Model: 3A-186DA15						
C1	S	264	<1 sec	F1	> 2.1	Observation: F1 opened; No hazards Damaged: — Temp: — Max. Voltage: —
D1	S	264	<1 sec	F1	> 2.1	Observation: F1 opened; No hazards Damaged: — Temp: — Max. Voltage: —
D8	S	264	10 min	F1	0.031	Observation: Unit shutdown; No hazards Damaged: — Temp: — Max. Voltage: —
ZD2	S	264	10 min	F1	0.044	Observation: Unit shutdown; No hazards Damaged: — Temp: — Max. Voltage: —
R10	S	264	<1 sec	F1	> 2.1	Observation: F1 opened; No hazards Damaged: — Temp: — Max. Voltage: —
U1 Pin 1-2	S	264	10 min	F1	0.019	Observation: Unit shutdown; No hazards Damaged: — Temp: — Max. Voltage: —

IEC 60950-1/Am1			
Clause	Requirement + Test	Result - Remark	Verdict

5.3	TABLE: Fault condition tests (continued)					P
Component No.	Fault	Supply voltage (V)	Test time	Fuse #	Fuse current (A)	Observation
U1 Pin 1-5	S	264	10 min	F1	0.019	Observation: Unit shutdown; No hazards Damaged: — Temp: — Max. Voltage: —
U1 Pin 2-5	S	264	10 min	F1	0.019	Observation: Unit shutdown; No hazards Damaged: — Temp: — Max. Voltage: —
U1 Pin 4-5	S	264	10 min	F1	0.019	Observation: Unit shutdown; No hazards Damaged: — Temp: — Max. Voltage: —
U1 Pin 6-5	S	264	10 min	F1	0.019	Observation: Unit shutdown; No hazards Damaged: — Temp: — Max. Voltage: —
PC1 Pin 1-2	S	264	10 min	F1	0.019	Observation: Unit shutdown; No hazards Damaged: — Temp: — Max. Voltage: —
PC1 Pin 3-4	S	264	10 min	F1	0.019	Observation: Unit shutdown; No hazards Damaged: — Temp: — Max. Voltage: —
PC1 Pin 1	O	264	10 min	F1	0.019	Observation: Unit shutdown; No hazards Damaged: — Temp: — Max. Voltage: —
PC1 Pin 3	O	264	10 min	F1	0.019	Observation: Unit shutdown; No hazards Damaged: — Temp: — Max. Voltage: —

IEC 60950-1/Am1			
Clause	Requirement + Test	Result - Remark	Verdict

5.3	TABLE: Fault condition tests (continued)						P
Component No.	Fault	Supply voltage (V)	Test time	Fuse #	Fuse current (A)	Observation	
Q1 (G-D)	S	264	<1 sec	F1	> 2.1	Observation: F1 opened; No hazards Damaged: Q1, R10 Temp: — Max. Voltage: —	
Q1 (D-S)	S	264	<1 sec	F1	> 2.1	Observation: F1 opened; No hazards Damaged: Q1, R10 Temp: — Max. Voltage: —	
Q1 (G-S)	S	264	10 min	F1	0.019	Observation: Unit shutdown; No hazards Damaged: — Temp: — Max. Voltage: —	
T1 Pin A-B	S	264	10 min	F1	0.035	Observation: Unit shutdown; No hazards Damaged: — Temp: — Max. Voltage: —	
T1 Pin 1-2	S	264	10 min	F1	0.043	Observation: Unit shutdown; No hazards Damaged: — Temp: — Max. Voltage: —	
T1 Pin 3-4	S	264	10 min	F1	0.033	Observation: Unit shutdown; No hazards Damaged: — Temp: — Max. Voltage: —	
Output	S	264	10 min	F1	0.019	Observation: Unit shutdown; No hazards Damaged: — Temp: — Max. Voltage: —	
Output	O/L	264	Steady state	F1	0.223	Total testing duration: 9 hours. Normal operation at output overload to max. 1.6 A. No hazards. Damage: — Temp: T1= 98.4°C, PC1= 69.7°C, Ambient= 24.5°C Max. Voltage: —	

IEC 60950-1/Am1			
Clause	Requirement + Test	Result - Remark	Verdict

5.3	TABLE: Fault condition tests (continued)					P
------------	---	--	--	--	--	----------

Component No.	Fault	Supply voltage (V)	Test time	Fuse #	Fuse current (A)	Observation
T1 pin A-B (after D8)	O/L	264	Steady state	F1	0.226	Total testing duration: 9 hours. Normal operation at output overload to max. 1.62 A. No hazards. Damage: — Temp: T1= 97.0°C, PC1= 69.7°C, Ambient= 25.8°C Max. Voltage: —

Supplementary information:

1. S: Short-circuited; O: Open-circuited; O/L: Overloaded; B: Blocked; L: Locked.
2. Observation: The observations during and after fault condition tests.
3. Damaged: Which component (components) damaged during the fault condition test.
4. Temp: The maximum temperature of transformer (T1) winding.
5. Max. Voltage: The maximum accessible voltage of DC output terminal during the fault condition test.

IEC 60950-1/Am1			
Clause	Requirement + Test	Result - Remark	Verdict

C.2	TABLE: transformers	P
------------	----------------------------	----------

Loc.	Tested insulation	Working voltage peak / V (2.10.2)	Working voltage rms / V (2.10.2)	Required electric strength (5.2)	Required clearance / mm (2.10.3)	Required creepage distance / mm (2.10.4)	Required distance thr. insul. (2.10.5)
Secondary pin to core (RI)	RI	488	268	3000 Vac	4.2	5.4	--
Primary winding to secondary winding (RI)	RI	488	268	3000 Vac	4.2	5.4	--
Loc.	Tested insulation			Test voltage/ V	Measured clearance / mm	Measured creepage dist./ mm	Measured distance thr. insul. / mm; number of layers
Secondary pin to core (RI)	RI			3000 Vac	6.2	6.2	--
Primary winding to secondary winding (RI)	RI			3000 Vac	6.5	6.5	

supplementary information:

- 1) The core of transformer (T1) is considered as primary winding.
- 2) The secondary wires are triple wire see appended table 1.5.1 for details.
- 3) The distances are measured along the insulating tape around the core of T1. Two layers insulating tape are provided between the core of transformer (T1) and secondary winding / components.
- 4) Additionally tubings are provided to prevent mechanical stress in the ends of two different secondary windings.

IEC 60950-1/Am1			
Clause	Requirement + Test	Result - Remark	Verdict

C.2	TABLE: transformers		P
------------	----------------------------	--	----------

Physical construction of power transformer T1(XF00577)

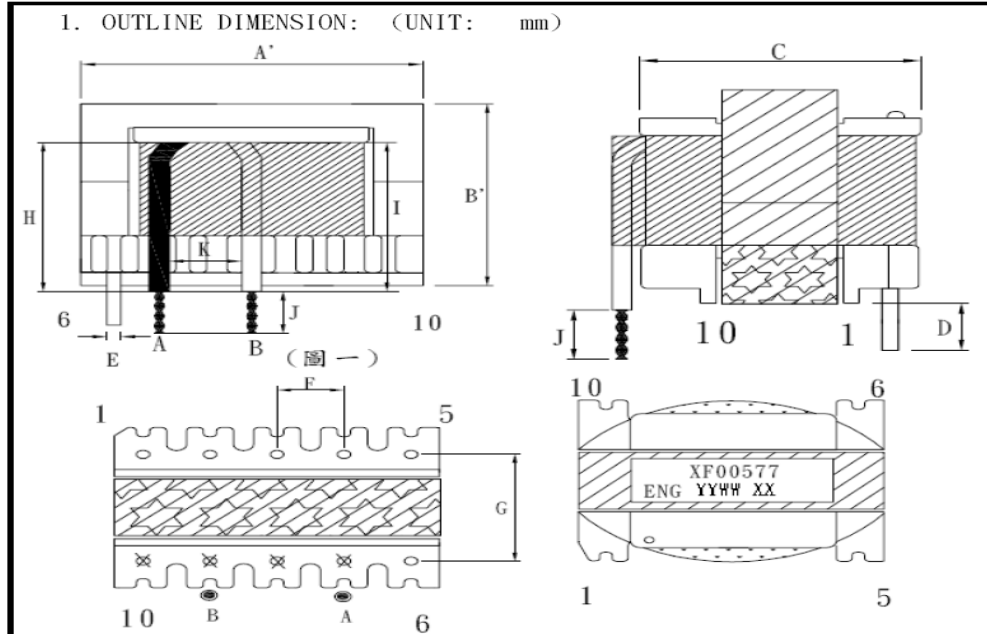

NOTE:

- 1) XX Indicate the Factory ID;
YY Provides production year;
WW Provides production week.
- 2) PIN7, 8, 9, 10 CUT OFF. PIN5 CUT OFF 1/2.
- 3) CORE TAPE UL (Y)3TS.
- 4) 標籤貼於產品頂部, 且字體朝PIN1-5 側.
- 5) 飛線A, B 鍍錫部份為3.5+/-1.0 且飛線成型以實合PCB 板為準.
- 6) 外觀圖中"C"項尺寸指BOBBIN 尺寸.
- 7) PIN端 CORE 須加工.

DIM	A'	B'	C	D	E	F	G	H	I	J	K
	MAX	MAX	MAX	±0.5	±0.1	±0.5	±0.5	±1.0	±1.0	±1.0	±1.0
SPEC	24	22	19	2.8	0.8	4	10.3	16.5	16.5	3.5	5
DESCRIPTION	TRANSFORMER		Customer P/N			XF00577	DATE	2009/7/16			

*PIN 端 CORE 加工圖: 用 3M 1350F-1*1L TAPE

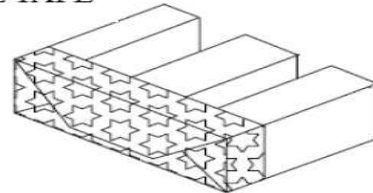

IEC 60950-1/Am1			
Clause	Requirement + Test	Result - Remark	Verdict

C.2 (cont.)	TABLE: transformers	P
-------------	---------------------	---

Physical construction of power transformer T1(XF00577) (cont.)

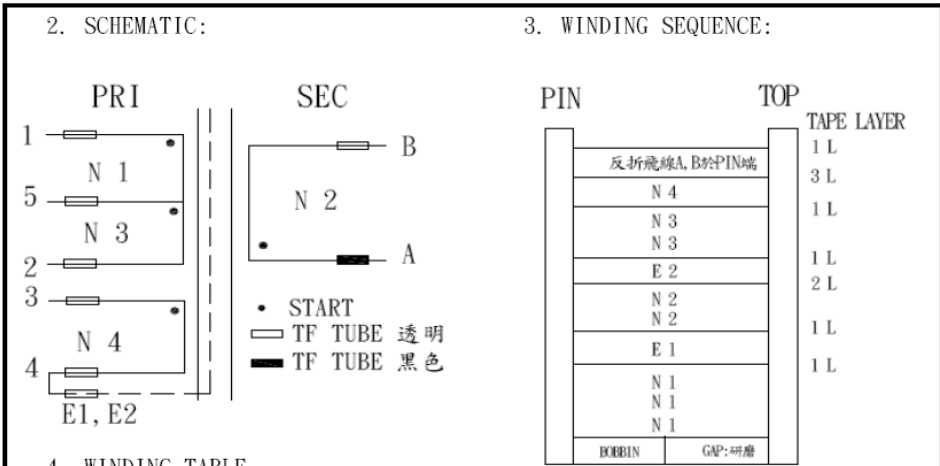

4. WINDING TABLE

Winding No (組別)	Margin Tape (擋牆膠帶)	PIN (腳位)	Wire&Wire Copper (線徑X股數)	Turns (圈數)	Winding Tape (繞線方式)	Tape Layer (膠帶層次)	Tube (套管)
N1	0	1-5	0.18ΦX2P	54Ts	密繞	1L	26*9/26*9
E1	0	~4	0.025X7mm	0.9Ts	背膠	1L	0/26*8
N2	0	A-B	0.40ΦX4P (三層絕緣線)	6Ts	密繞	2L	14*32(黑色)/14*32(透明)
E2	0	~4	0.025X7mm	0.9Ts	背膠	1L	0/26*8
N3	0	5-2	0.18ΦX2P	36Ts	密繞	1L	26*14/26*14
N4	0	3-4	0.20ΦX1P	16Ts	密中繞	3L	26*14/26*14
反折飛線A, B 於PIN端.						1L	

NOTE:

- PIN1朝內插. 產品不須加擋牆膠帶, 進出線須加TF TUBE.
- N1為密繞, 佔三層, 層間不須層隔.
- N3為密繞佔兩層餘, 層間不須層隔., 餘圈直接密繞其上.
- N2為密繞, 佔兩層, 層間不須層隔, 且使用三層絕緣線繞制, 須先剝皮再鍍錫. A', B' 均為飛線, A' 穿黑色套管從PIN6~7 側頂部進線. B' 穿透明套管從PIN7~8側頂部出線, (飛線尺寸如外觀圖所示)
- E1, E2 為內銅(背膠), 從無線端起繞, 接引線0.3φ*1P於PIN4.
- N4 為密中繞, 佔一層. (N4 繞完後, 將飛線A, B 往下折, 再包TAPE 1TS.)

DESCRIPTION	TRANSFORMER	Customer P/N	XF00577	DATE	2009/7/16
-------------	-------------	--------------	---------	------	-----------

IEC 60950-1/Am1			
Clause	Requirement + Test	Result - Remark	Verdict

C.2 (cont.)	TABLE: transformers	P
-------------	---------------------	---

Physical construction of power transformer T1(XF00578)

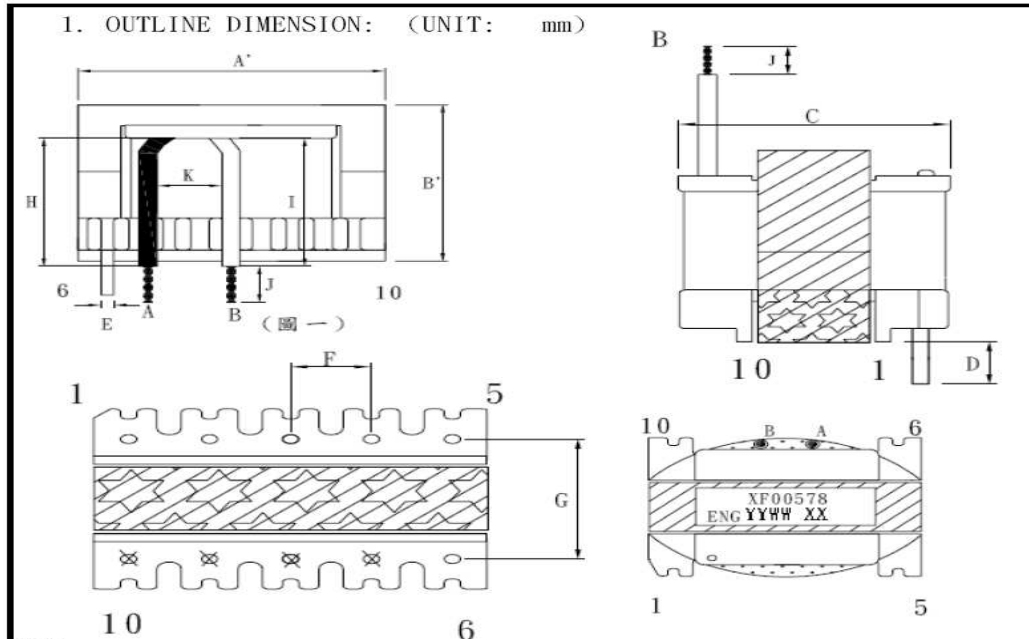

NOTE:

- 1) XX Indicate the Factory ID;
YY Provides production year;
WW Provides production week.
- 2) PIN7, 8, 9, 10 CUT OFF. PIN5 CUT OFF 1/2.
- 3) PIN 端CORE 須加工.
- 4) CORE TAPE UL (Y)3TS.
- 5) 標籤貼於產品頂部, 且字體朝PIN1-5 側.
- 6) 飛線A, B 鍍錫部份為3.5+/-1.0 且飛線成型以實合PCB 板為準.
- 7) 外觀圖中 "C" 項尺寸指BOBBIN 尺寸.

DIM	A'	B'	C	D	E	F	G	H	I	J	K
	SPEC	MAX	MAX	MAX	±0.5	±0.1	±0.5	±0.5	±1.0	±1.0	±1.0
DESCRIPTION	TRANSFORMER			Customer P/N			XF00578	DATE	2009/7/16		

IEC 60950-1/Am1			
Clause	Requirement + Test	Result - Remark	Verdict

C.2 (cont.)	TABLE: transformers	P
-------------	---------------------	---

Physical construction of power transformer T1(XF00578) (cont.)

2. SCHEMATIC:

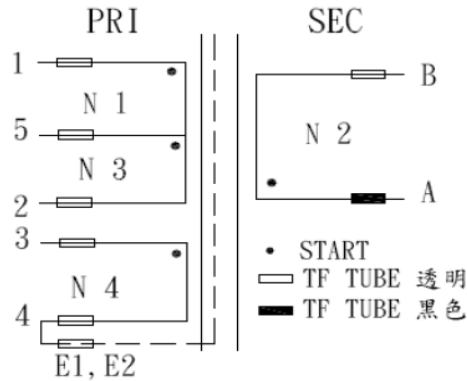

3. WINDING SEQUENCE:

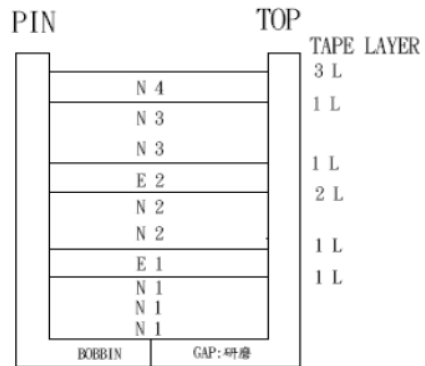

4. WINDING TABLE

Winding No (組別)	Margin Tape (擋牆膠帶)	PIN (腳位)	Wire&Wire Copper (線徑X股數)	Turns (圈數)	Winding Tape (繞線方式)	Tape Layer (膠帶層次)	Tube (套管)
N1	0	1-5	0.18ΦX2P	54Ts	密繞	1L	26*11/26*11
E1	0	~4	0.025X7mm	0.9Ts	背膠	1L	0/26*8
N2	0	A-B	0.35ΦX2P (三層絕緣線)	12Ts	密繞	2L	18*30(黑色)/18*30(透明)
E2	0	~4	0.025X7mm	0.9Ts	背膠	1L	0/26*8
N3	0	5-2	0.18ΦX2P	36Ts	密繞	1L	26*10/26*10
N4	0	3-4	0.20ΦX1P	15Ts	密中繞	3L	30*10/30*10

NOTE:

1. 產品不須加擋牆膠帶, 進出線須加TF TUBE.
2. N1為密繞, 占三層, 層間不須層隔.
3. N3為密繞占兩層餘, 層間不須層隔, 餘圈直接密繞其上.
4. N2為密繞, 佔兩層, 層間不須層隔, 且使用三層絕緣線繞制, 須先剝皮再鍍錫. A, B均為飛線, A穿黑色套管從PIN6~7頂部進線. B穿透明套管從PIN7~8頂部出線, (飛線尺寸如外觀圖所示).
5. E1, E2 為內銅(背膠), 從無線端起繞, 接引線0.3Φ*1P於PIN4.
6. N4為密中繞占一層.

DESCRIPTION	TRANSFORMER	Customer P/N	XF00578	DATE	2009/7/16
-------------	-------------	--------------	---------	------	-----------



IEC 60950-1/Am1			
Clause	Requirement + Test	Result - Remark	Verdict

List of test equipment used:

(Note: This is an example of the required attachment. Other forms with a different layout but containing similar information are also acceptable.)

Clause	Measurement / testing	Testing / measuring equipment / material used	Range used	Calibration date

Note:
Refer to the project file.



2.1.1.7	TABLE: Stored discharge on capacitors test			P
Test conditions:	τ calculated (s)	τ measured (s)	$t_u \rightarrow 0$ (s)	Remarks:
Output with no load	0.66	0.476	1.8	After 1 s, measured 48 V _{peak} (limit: Max. voltage 378 V _{peak} X 37 % = 139 V _{peak})
Supplementary information:				
1. X-Capacitor(s) installed for testing: 0.22 μ F (CX1 = 0.22 μ F)				
2. Bleeding resistor(s): 3M ohm (R1 = R2 = 1.5 Mohm)				

2.4.2	TABLE: Limited current circuits measurement				P
Location	Voltage (V _{peak})	Current (mA)	Frequency (KHz)	Limit (mA)	Comments
CY1 secondary to earth	0.63	0.31	0.06	0.7	—
CY1 secondary to earth	0.80	0.40	19.8	13.8	—
Supplementary information:					
Test voltage: 264 Vac / 60 Hz					
Rating of bridging components: CY1, measured Max. 1000 pF; CY2, measured Max. 100 pF					

2.6.3.4	TABLE: Resistance of earthing conductors and their terminals test			N/A
location	resistance measured (m Ω)	limit	comments	
location	drop voltage measured (V)	limit	comments	
Supplementary information:				



4.6.1, 4.6.2	TABLE: Enclosure openings		N/A
location	size (mm)	comments	
Supplementary information:			

4.6.4	TABLE: Enclosure openings in transportable equipment		N/A
location	size (mm)	comments	
Supplementary information:			



IEC60950_1B - ATTACHMENT			
Clause	Requirement + Test	Result - Remark	Verdict

ATTACHMENT TO TEST REPORT IEC 60950-1 EUROPEAN GROUP DIFFERENCES AND NATIONAL DIFFERENCES Information technology equipment – Safety – PART 1: GENERAL REQUIREMENTS			
Differences according to.....: EN 60950-1:2006/A11:2009/A1:2010			
Attachment Form No.....: EU_GD_IEC60950_1B			
Attachment Originator.....: SGS Fimko Ltd			
Master Attachment.....: Date (2010-04)			
Copyright © 2010 IEC System for Conformity Testing and Certification of Electrical Equipment (IECEE), Geneva, Switzerland. All rights reserved.			

EN 60950-1:2006/A11:2009/A1:2010 – CENELEC COMMON MODIFICATIONS
--

IEC 60950-1, GROUP DIFFERENCES (CENELEC common modifications EN)			
Clause	Requirement + Test	Result - Remark	Verdict
Contents	Add the following annexes: Annex ZA (normative) Normative references to international publications with their corresponding European publications Annex ZB (normative) Special national conditions		P
General	Delete all the “country” notes in the reference document (IEC 60950-1:2005) according to the following list: 1.4.8 Note 2 1.5.1 Note 2 & 3 1.5.7.1 Note 1.5.8 Note 2 1.5.9.4 Note 1.7.2.1 Note 4, 5 & 6 2.2.3 Note 2.2.4 Note 2.3.2 Note 2.3.2.1 Note 2 2.3.4 Note 2 2.6.3.3 Note 2 & 3 2.7.1 Note 2.10.3.2 Note 2 2.10.5.13 Note 3 3.2.1.1 Note 3.2.4 Note 3. 2.5.1 Note 2 4.3.6 Note 1 & 2 4.7 Note 4 4.7.2.2 Note 4.7.3.1 Note 2 5.1.7.1 Note 3 & 4 5.3.7 Note 1 6 Note 2 & 5 6.1.2.1 Note 2 6.1.2.2 Note 6.2.2 Note 6.2.2.1 Note 2 6.2.2.2 Note 7.1 Note 3 7.2 Note 7.3 Note 1 & 2 G.2.1 Note 2 Annex H Note 2		P
General (A1:2010)	Delete all the “country” notes in the reference document (IEC 60950-1:2005/A1:2010) according to the following list: 1.5.7.1 Note 6.1.2.1 Note 2 6.2.2.1 Note 2 EE.3 Note		P

IEC60950_1B - ATTACHMENT			
Clause	Requirement + Test	Result - Remark	Verdict
IEC 60950-1, GROUP DIFFERENCES (CENELEC common modifications EN)			
Clause	Requirement + Test	Result - Remark	Verdict
1.3.Z1	<p>Add the following subclause:</p> <p>1.3.Z1 Exposure to excessive sound pressure</p> <p>The apparatus shall be so designed and constructed as to present no danger when used for its intended purpose, either in normal operating conditions or under fault conditions, particularly providing protection against exposure to excessive sound pressures from headphones or earphones.</p> <p>NOTE Z1 A new method of measurement is described in EN 50332-1, Sound system equipment: Headphones and earphones associated with portable audio equipment - Maximum sound pressure level measurement methodology and limit considerations - Part 1: General method for "one package equipment", and in EN 50332-2, Sound system equipment: Headphones and earphones associated with portable audio equipment - Maximum sound pressure level measurement methodology and limit considerations - Part 2: Guidelines to associate sets with headphones coming from different manufacturers.</p>	Considered	N/A
1.5.1	<p>Add the following NOTE:</p> <p>NOTE Z1 The use of certain substances in electrical and electronic equipment is restricted within the EU: see Directive 2002/95/EC</p>		N/A
1.7.2.1 (A1:2010)	<p>In addition, for a PORTABLE SOUND SYSTEM, the instructions shall include a warning that excessive sound pressure from earphones and headphones can cause hearing loss.</p>		N/A
2.7.1	<p>Replace the subclause as follows:</p> <p>Basic requirements</p> <p>To protect against excessive current, short-circuits and earth faults in PRIMARY CIRCUITS, protective devices shall be included either as integral parts of the equipment or as parts of the building installation, subject to the following, a), b) and c):</p> <p>a) except as detailed in b) and c), protective devices necessary to comply with the requirements of 5.3 shall be included as parts of the equipment;</p> <p>b) for components in series with the mains input to the equipment such as the supply cord, appliance coupler, r.f.i. filter and switch, short-circuit and earth fault protection may be provided by protective devices in the building installation;</p>	Considered	P

IEC60950_1B - ATTACHMENT									
Clause	Requirement + Test	Result - Remark	Verdict						
IEC 60950-1, GROUP DIFFERENCES (CENELEC common modifications EN)									
Clause	Requirement + Test	Result - Remark	Verdict						
	<p>c) it is permitted for PLUGGABLE EQUIPMENT TYPE B or PERMANENTLY CONNECTED EQUIPMENT, to rely on dedicated overcurrent and short-circuit protection in the building installation, provided that the means of protection, e.g. fuses or circuit breakers, is fully specified in the installation instructions.</p> <p>If reliance is placed on protection in the building installation, the installation instructions shall so state, except that for PLUGGABLE EQUIPMENT TYPE A the building installation shall be regarded as providing protection in accordance with the rating of the wall socket outlet.</p>		P						
2.7.2	This subclause has been declared 'void'.		N/A						
3.2.3	Delete the NOTE in Table 3A, and delete also in this table the conduit sizes in parentheses.		N/A						
3.2.5.1	<p>Replace "60245 IEC 53" by "H05 RR-F"; "60227 IEC 52" by "H03 VV-F or H03 VVH2-F"; "60227 IEC 53" by "H05 VV-F or H05 VVH2-F2".</p> <p>In Table 3B, replace the first four lines by the following:</p> <table border="0"> <tr> <td>Up to and including 6 </td> <td>0,75^{a)} </td> </tr> <tr> <td>Over 6 up to and including 10 </td> <td>(0,75)^{b)} 1,0 </td> </tr> <tr> <td>Over 10 up to and including 16 </td> <td>(1,0)^{c)} 1,5 </td> </tr> </table> <p>In the conditions applicable to Table 3B delete the words "in some countries" in condition^{a)}.</p> <p>In NOTE 1, applicable to Table 3B, delete the second sentence.</p>	Up to and including 6	0,75 ^{a)}	Over 6 up to and including 10	(0,75) ^{b)} 1,0	Over 10 up to and including 16	(1,0) ^{c)} 1,5		N/A
Up to and including 6	0,75 ^{a)}								
Over 6 up to and including 10	(0,75) ^{b)} 1,0								
Over 10 up to and including 16	(1,0) ^{c)} 1,5								
3.3.4	<p>In Table 3D, delete the fourth line: conductor sizes for 10 to 13 A, and replace with the following:</p> <table border="0"> <tr> <td>Over 10 up to and including 16 </td> <td>1,5 to 2,5 </td> <td>1,5 to 4 </td> </tr> </table> <p>Delete the fifth line: conductor sizes for 13 to 16 A</p>	Over 10 up to and including 16	1,5 to 2,5	1,5 to 4		N/A			
Over 10 up to and including 16	1,5 to 2,5	1,5 to 4							
4.3.13.6 (A1:2010)	<p>Replace the existing NOTE by the following:</p> <p>NOTE Z1 Attention is drawn to:</p> <p>1999/519/EC: Council Recommendation on the limitation of exposure of the general public to electromagnetic fields 0 Hz to 300 GHz, and</p> <p>2006/25/EC: Directive on the minimum health and safety requirements regarding the exposure of workers to risks arising from physical agents (artificial optical radiation).</p>	(For radiation)	N/A						

IEC60950_1B - ATTACHMENT			
Clause	Requirement + Test	Result - Remark	Verdict
IEC 60950-1, GROUP DIFFERENCES (CENELEC common modifications EN)			
Clause	Requirement + Test	Result - Remark	Verdict
	Standards taking into account mentioned Recommendation and Directive which demonstrate compliance with the applicable EU Directive are indicated in the OJEC.		N/A
Annex H	<p>Replace the last paragraph of this annex by:</p> <p>At any point 10 cm from the surface of the OPERATOR ACCESS AREA, the dose rate shall not exceed 1 µSv/h (0,1 mR/h) (see NOTE). Account is taken of the background level.</p> <p>Replace the notes as follows:</p> <p>NOTE These values appear in Directive 96/29/Euratom.</p> <p>Delete NOTE 2.</p>	(For radiation)	N/A
Bibliography	Additional EN standards.		—

ZA	NORMATIVE REFERENCES TO INTERNATIONAL PUBLICATIONS WITH THEIR CORRESPONDING EUROPEAN PUBLICATIONS	—
-----------	--	---

ZB ANNEX (normative)			
SPECIAL NATIONAL CONDITIONS (EN)			
Clause	Requirement + Test	Result - Remark	Verdict
1.2.4.1	In Denmark , certain types of Class I appliances (see 3.2.1.1) may be provided with a plug not establishing earthing conditions when inserted into Danish socket-outlets.		N/A
1.2.13.14	In Norway and Sweden , for requirements see 1.7.2.1 and 7.3 of this annex.		N/A
1.5.7.1	In Finland, Norway and Sweden , resistors bridging BASIC INSULATION in CLASS I PLUGGABLE EQUIPMENT TYPE A must comply with the requirements in 1.5.7.1. In addition when a single resistor is used, the resistor must withstand the resistor test in 1.5.7.2.		N/A
1.5.8	In Norway , due to the IT power system used (see annex V, Figure V.7), capacitors are required to be rated for the applicable line-to-line voltage (230 V).		N/A
1.5.9.4	In Finland, Norway and Sweden , the third dashed sentence is applicable only to equipment as defined in 6.1.2.2 of this annex.		N/A

IEC60950_1B - ATTACHMENT			
Clause	Requirement + Test	Result - Remark	Verdict
ZB ANNEX (normative) SPECIAL NATIONAL CONDITIONS (EN)			
Clause	Requirement + Test	Result - Remark	Verdict
1.7.2.1	<p>In Finland, Norway and Sweden, CLASS I PLUGGABLE EQUIPMENT TYPE A intended for connection to other equipment or a network shall, if safety relies on connection to protective earth or if surge suppressors are connected between the network terminals and accessible parts, have a marking stating that the equipment must be connected to an earthed mains socket-outlet.</p> <p>The marking text in the applicable countries shall be as follows:</p> <p>In Finland: "Laite on liitettävä suojakoskettimilla varustettuun pistorasiaan"</p> <p>In Norway: "Apparatet må tilkoples jordet stikkontakt"</p> <p>In Sweden: "Apparaten skall anslutas till jordat uttag"</p> <p>In Norway and Sweden, the screen of the cable distribution system is normally not earthed at the entrance of the building and there is normally no equipotential bonding system within the building. Therefore the protective earthing of the building installation need to be isolated from the screen of a cable distribution system.</p> <p>It is however accepted to provide the insulation external to the equipment by an adapter or an interconnection cable with galvanic isolator, which may be provided by e.g. a retailer.</p> <p>The user manual shall then have the following or similar information in Norwegian and Swedish language respectively, depending on in what country the equipment is intended to be used in:</p> <p>"Equipment connected to the protective earthing of the building installation through the mains connection or through other equipment with a connection to protective earthing – and to a cable distribution system using coaxial cable, may in some circumstances create a fire hazard. Connection to a cable distribution system has therefore to be provided through a device providing electrical isolation below a certain frequency range (galvanic isolator, see EN 60728-11)."</p>		N/A

IEC60950_1B - ATTACHMENT			
Clause	Requirement + Test	Result - Remark	Verdict
ZB ANNEX (normative)			
SPECIAL NATIONAL CONDITIONS (EN)			
Clause	Requirement + Test	Result - Remark	Verdict
	<p>NOTE In Norway, due to regulation for installations of cable distribution systems, and in Sweden, a galvanic isolator shall provide electrical insulation below 5 MHz. The insulation shall withstand a dielectric strength of 1,5 kV r.m.s., 50 Hz or 60 Hz, for 1 min.</p> <p>Translation to Norwegian (the Swedish text will also be accepted in Norway): "Utstyr som er koplet til beskyttelsesjord via nettplugg og/eller via annet jordtilkoplet utstyr – og er tilkoplet et kabel-TV nett, kan forårsake brannfare. For å unngå dette skal det ved tilkopling av utstyret til kabel-TV nettet installeres en galvanisk isolator mellom utstyret og kabel- TV nettet." Translation to Swedish: "Utrustning som är kopplad till skyddsjord via jordat vägguttag och/eller via annan utrustning och samtidigt är kopplad till kabel-TV nät kan i vissa fall medföra risk för brand. För att undvika detta skall vid anslutning av utrustningen till kabel-TV nät galvanisk isolator finnas mellan utrustningen och kabel-TV nätet."</p>		N/A
1.7.5	<p>In Denmark, socket-outlets for providing power to other equipment shall be in accordance with the Heavy Current Regulations, Section 107-2-D1, Standard Sheet DK 1-3a, DK 1-5a or DK 1-7a, when used on Class I equipment. For STATIONARY EQUIPMENT the socket-outlet shall be in accordance with Standard Sheet DK 1-1b or DK 1-5a.</p> <p>For CLASS II EQUIPMENT the socket outlet shall be in accordance with Standard Sheet DKA 1-4a.</p>		N/A
2.2.4	In Norway , for requirements see 1.7.2.1, 6.1.2.1 and 6.1.2.2 of this annex.		N/A
2.3.2	In Finland, Norway and Sweden there are additional requirements for the insulation. See 6.1.2.1 and 6.1.2.2 of this annex.		N/A
2.3.4	In Norway , for requirements see 1.7.2.1, 6.1.2.1 and 6.1.2.2 of this annex.		N/A
2.6.3.3	In the United Kingdom , the current rating of the circuit shall be taken as 13 A, not 16 A.		N/A

IEC60950_1B - ATTACHMENT			
Clause	Requirement + Test	Result - Remark	Verdict
ZB ANNEX (normative)			
SPECIAL NATIONAL CONDITIONS (EN)			
Clause	Requirement + Test	Result - Remark	Verdict
2.7.1	In the United Kingdom , to protect against excessive currents and short-circuits in the PRIMARY CIRCUIT of DIRECT PLUG-IN EQUIPMENT, tests according to 5.3 shall be conducted, using an external protective device rated 30 A or 32 A. If these tests fail, suitable protective devices shall be included as integral parts of the DIRECT PLUG-IN EQUIPMENT, so that the requirements of 5.3 are met.		P
2.10.5.13	In Finland, Norway and Sweden , there are additional requirements for the insulation, see 6.1.2.1 and 6.1.2.2 of this annex.		N/A
3.2.1.1	<p>In Switzerland, supply cords of equipment having a RATED CURRENT not exceeding 10 A shall be provided with a plug complying with SEV 1011 or IEC 60884-1 and one of the following dimension sheets:</p> <p>SEV 6532-2.1991 Plug Type 15 3P+N+PE 250/400 V, 10 A</p> <p>SEV 6533-2.1991 Plug Type 11 L+N 250 V, 10 A</p> <p>SEV 6534-2.1991 Plug Type 12 L+N+PE 250 V, 10 A</p> <p>In general, EN 60309 applies for plugs for currents exceeding 10 A. However, a 16 A plug and socket-outlet system is being introduced in Switzerland, the plugs of which are according to the following dimension sheets, published in February 1998:</p> <p>SEV 5932-2.1998: Plug Type 25 , 3L+N+PE 230/400 V, 16 A</p> <p>SEV 5933-2.1998: Plug Type 21, L+N, 250 V, 16A</p> <p>SEV 5934-2.1998: Plug Type 23, L+N+PE .250 V, 16 A</p>		N/A

IEC60950_1B - ATTACHMENT			
Clause	Requirement + Test	Result - Remark	Verdict
ZB ANNEX (normative)			
SPECIAL NATIONAL CONDITIONS (EN)			
Clause	Requirement + Test	Result - Remark	Verdict
3.2.1.1	<p>In Denmark, supply cords of single-phase equipment having a rated current not exceeding 13 A shall be provided with a plug according to the Heavy Current Regulations, Section 107-2-D1.</p> <p>CLASS I EQUIPMENT provided with socket-outlets with earth contacts or which are intended to be used in locations where protection against indirect contact is required according to the wiring rules shall be provided with a plug in accordance with standard sheet DK 2-1a or DK 2-5a.</p> <p>If poly-phase equipment and single-phase equipment having a RATED CURRENT exceeding 13 A is provided with a supply cord with a plug, this plug shall be in accordance with the Heavy Current Regulations, Section 107-2-D1 or EN 60309-2.</p>		N/A
3.2.1.1	<p>In Spain, supply cords of single-phase equipment having a rated current not exceeding 10 A shall be provided with a plug according to UNE 20315:1994.</p> <p>Supply cords of single-phase equipment having a rated current not exceeding 2,5 A shall be provided with a plug according to UNE-EN 50075:1993.</p> <p>CLASS I EQUIPMENT provided with socket-outlets with earth contacts or which are intended to be used in locations where protection against indirect contact is required according to the wiring rules, shall be provided with a plug in accordance with standard UNE 20315:1994.</p> <p>If poly-phase equipment is provided with a supply cord with a plug, this plug shall be in accordance with UNE-EN 60309-2.</p>		N/A
3.2.1.1	<p>In the United Kingdom, apparatus which is fitted with a flexible cable or cord and is designed to be connected to a mains socket conforming to BS 1363 by means of that flexible cable or cord and plug, shall be fitted with a 'standard plug' in accordance with Statutory Instrument 1768:1994 - The Plugs and Sockets etc. (Safety) Regulations 1994, unless exempted by those regulations.</p> <p>NOTE 'Standard plug' is defined in SI 1768:1994 and essentially means an approved plug conforming to BS 1363 or an approved conversion plug.</p>		N/A

IEC60950_1B - ATTACHMENT			
Clause	Requirement + Test	Result - Remark	Verdict
ZB ANNEX (normative)			
SPECIAL NATIONAL CONDITIONS (EN)			
Clause	Requirement + Test	Result - Remark	Verdict
3.2.1.1	In Ireland , apparatus which is fitted with a flexible cable or cord and is designed to be connected to a mains socket conforming to I.S. 411 by means of that flexible cable or cord and plug, shall be fitted with a 13 A plug in accordance with Statutory Instrument 525:1997 - National Standards Authority of Ireland (section 28) (13 A Plugs and Conversion Adaptors for Domestic Use) Regulations 1997.		N/A
3.2.4	In Switzerland , for requirements see 3.2.1.1 of this annex.		N/A
3.2.5.1	In the United Kingdom , a power supply cord with conductor of 1,25 mm ² is allowed for equipment with a rated current over 10 A and up to and including 13 A.		N/A
3.3.4	In the United Kingdom , the range of conductor sizes of flexible cords to be accepted by terminals for equipment with a RATED CURRENT of over 10 A up to and including 13 A is: <ul style="list-style-type: none"> • 1,25 mm² to 1,5 mm² nominal cross-sectional area. 		N/A
4.3.6	In the United Kingdom , the torque test is performed using a socket outlet complying with BS 1363 part 1:1995, including Amendment 1:1997 and Amendment 2:2003 and the plug part of DIRECT PLUG-IN EQUIPMENT shall be assessed to BS 1363: Part 1, 12.1, 12.2, 12.3, 12.9, 12.11, 12.12, 12.13, 12.16 and 12.17, except that the test of 12.17 is performed at not less than 125 °C. Where the metal earth pin is replaced by an Insulated Shutter Opening Device (ISOD), the requirements of clauses 22.2 and 23 also apply.		N/A
4.3.6	In Ireland , DIRECT PLUG-IN EQUIPMENT is known as plug similar devices. Such devices shall comply with Statutory Instrument 526:1997 - National Standards Authority of Ireland (Section 28) (Electrical plugs, plug similar devices and sockets for domestic use) Regulations, 1997.		N/A

IEC60950_1B - ATTACHMENT			
Clause	Requirement + Test	Result - Remark	Verdict
ZB ANNEX (normative)			
SPECIAL NATIONAL CONDITIONS (EN)			
Clause	Requirement + Test	Result - Remark	Verdict
5.1.7.1	<p>In Finland, Norway and Sweden TOUCH CURRENT measurement results exceeding 3,5 mA r.m.s. are permitted only for the following equipment:</p> <ul style="list-style-type: none"> • STATIONARY PLUGGABLE EQUIPMENT TYPE A that <ul style="list-style-type: none"> is intended to be used in a RESTRICTED ACCESS LOCATION where equipotential bonding has been applied, for example, in a telecommunication centre; and has provision for a permanently connected PROTECTIVE EARTHING CONDUCTOR; and is provided with instructions for the installation of that conductor by a SERVICE PERSON; • STATIONARY PLUGGABLE EQUIPMENT TYPE B; • STATIONARY PERMANENTLY CONNECTED EQUIPMENT. 		N/A

IEC60950_1B - ATTACHMENT			
Clause	Requirement + Test	Result - Remark	Verdict
ZB ANNEX (normative)			
SPECIAL NATIONAL CONDITIONS (EN)			
Clause	Requirement + Test	Result - Remark	Verdict
6.1.2.1 (A1:2010)	<p>In Finland, Norway and Sweden, add the following text between the first and second paragraph of the compliance clause:</p> <p>If this insulation is solid, including insulation forming part of a component, it shall at least consist of either</p> <ul style="list-style-type: none"> - two layers of thin sheet material, each of which shall pass the electric strength test below, or - one layer having a distance through insulation of at least 0,4 mm, which shall pass the electric strength test below. <p>Alternatively for components, there is no distance through insulation requirements for the insulation consisting of an insulating compound completely filling the casing, so that CLEARANCES and CREEPAGE DISTANCES do not exist, if the component passes the electric strength test in accordance with the compliance clause below and in addition</p> <ul style="list-style-type: none"> - passes the tests and inspection criteria of 2.10.11 with an electric strength test of 1,5 kV multiplied by 1,6 (the electric strength test of 2.10.10 shall be performed using 1,5 kV), and - is subject to ROUTINE TESTING for electric strength during manufacturing, using a test voltage of 1,5 kV. 		N/A

IEC60950_1B - ATTACHMENT			
Clause	Requirement + Test	Result - Remark	Verdict
ZB ANNEX (normative)			
SPECIAL NATIONAL CONDITIONS (EN)			
Clause	Requirement + Test	Result - Remark	Verdict
	<p>It is permitted to bridge this insulation with an optocoupler complying with 2.10.5.4 b).</p> <p>It is permitted to bridge this insulation with a capacitor complying with EN 60384-14:2005, subclass Y2.</p> <p>A capacitor classified Y3 according to EN 60384-14:2005, may bridge this insulation under the following conditions:</p> <ul style="list-style-type: none"> - the insulation requirements are satisfied by having a capacitor classified Y3 as defined by EN 60384-14, which in addition to the Y3 testing, is tested with an impulse test of 2,5 kV defined in EN 60950-1:2006, 6.2.2.1; - the additional testing shall be performed on all the test specimens as described in EN 60384-14; - the impulse test of 2,5 kV is to be performed before the endurance test in EN 60384-14, in the sequence of tests as described in EN 60384-14. 		N/A
6.1.2.2	In Finland, Norway and Sweden , the exclusions are applicable for PERMANENTLY CONNECTED EQUIPMENT, PLUGGABLE EQUIPMENT TYPE B and equipment intended to be used in a RESTRICTED ACCESS LOCATION where equipotential bonding has been applied, e.g. in a telecommunication centre, and which has provision for a permanently connected PROTECTIVE EARTHING CONDUCTOR and is provided with instructions for the installation of that conductor by a SERVICE PERSON.		N/A
7.2	In Finland, Norway and Sweden , for requirements see 6.1.2.1 and 6.1.2.2 of this annex. The term TELECOMMUNICATION NETWORK in 6.1.2 being replaced by the term CABLE DISTRIBUTION SYSTEM.	The EUT is not connected to cable distribution system	N/A
7.3	In Norway and Sweden , for requirements see 1.2.13.14 and 1.7.2.1 of this annex.		N/A
7.3	In Norway , for installation conditions see EN 60728-11:2005.		N/A

IEC60950_1B - ATTACHMENT			
Clause	Requirement + Test	Result - Remark	Verdict
ATTACHMENT TO TEST REPORT IEC 60950-1 EUROPEAN GROUP DIFFERENCES AND NATIONAL DIFFERENCES Information technology equipment – Safety – PART 1: GENERAL REQUIREMENTS EN 60950-1:2006/A12: 2011 – CENELEC COMMON MODIFICATIONS			

1.3.Z1	in EN 60950-1:2006 Delete the addition of 1.3.Z1		N/A
1.2.3	in EN 60950-1:2006/A1:2010 Delete the definition 1.2.3.Z1		N/A
1.7.2.1	in EN 60950-1:2006 and EN 60950-1:2006/A1:2010 Delete NOTE Z1 and the addition for Portable Sound System Add the following clause and annex to the existing standard and amendments		N/A
Zx.	Protection against excessive sound pressure from personal music players		N/A

IEC60950_1B - ATTACHMENT			
Clause	Requirement + Test	Result - Remark	Verdict
Zx.1	<p>General</p> <p>This sub-clause specifies requirements for protection against excessive sound pressure from personal music players that are closely coupled to the ear. It also specifies requirements for earphones and headphones intended for use with personal music players.</p> <p>A personal music player is a portable equipment for personal use, that:</p> <ul style="list-style-type: none"> is designed to allow the user to listen to recorded or broadcast sound or video; and primarily uses headphones or earphones that can be worn in or on or around the ears; and allows the user to walk around while in use. <p>NOTE 1 Examples are hand-held or body-worn portable CD players, MP3 audio players, mobile phones with MP3 type features, PDA's or similar equipment.</p> <p>A personal music player and earphones or headphones intended to be used with personal music players shall comply with the requirements of this sub-clause.</p> <p>The requirements in this sub-clause are valid for music or video mode only.</p> <p>The requirements do not apply:</p> <ul style="list-style-type: none"> while the personal music player is connected to an external amplifier; or while the headphones or earphones are not used. <p>NOTE 2 An external amplifier is an amplifier which is not part of the personal music player or the listening device, but which is intended to play the music as a standalone music player.</p> <p>The requirements do not apply to:</p> <ul style="list-style-type: none"> hearing aid equipment and professional equipment; <p>NOTE 3 Professional equipment is equipment sold through special sales channels. All products sold through normal electronics stores are considered not to be professional equipment.</p> <p>analogue personal music players (personal music players without any kind of digital processing of the sound signal) that are brought to the market before the end of 2015.</p> <p>NOTE 4 This exemption has been allowed because this technology is falling out of use and it is expected that within a few years it will no longer exist. This exemption will not be extended to other technologies.</p> <p>For equipment which is clearly designed or intended for use by young children, the limits of EN 71-1 apply</p>		N/A

IEC60950_1B - ATTACHMENT			
Clause	Requirement + Test	Result - Remark	Verdict
Zx.2	<p>Equipment requirements</p> <p>No safety provision is required for equipment that complies with the following:</p> <ul style="list-style-type: none"> -equipment provided as a package (personal music player with its listening device), where the acoustic output LAeq,T is ≤ 85 dBA measured while playing the fixed “programme simulation noise” as described in EN 50332-1; and a personal music player provided with an analogue electrical output socket for a listening device, where the electrical output is ≤ 27 mV measured as described in EN 50332-2, while playing the fixed “programme simulation noise” as described in EN 50332-1. <p>NOTE 1 Wherever the term acoustic output is used in this clause, the 30 s A-weighted equivalent sound pressure level LAeq,T is meant. See also Zx.5 and Annex Zx.</p> <p>All other equipment shall:</p> <ul style="list-style-type: none"> a) protect the user from unintentional acoustic outputs exceeding those mentioned above; and b) have a standard acoustic output level not exceeding those mentioned above, and automatically return to an output level not exceeding those mentioned above when the power is switched off; and c) provide a means to actively inform the user of the increased sound pressure when the equipment is operated with an acoustic output exceeding those mentioned above. Any means used shall be acknowledged by the user before activating a mode of operation which allows for an acoustic output exceeding those mentioned above. The acknowledgement does not need to be repeated more than once every 20 h of cumulative listening time; and <p>NOTE 2 Examples of means include visual or audible signals. Action from the user is always required.</p> <p>NOTE 3 The 20 h listening time is the accumulative listening time, independent how often and how long the personal music player has been switched off.</p> <ul style="list-style-type: none"> d) have a warning as specified in Zx.3; and e) not exceed the following: <ul style="list-style-type: none"> 1) equipment provided as a package (player with its listening device), the acoustic output shall be ≤ 100 dBA measured while playing the fixed “programme simulation noise” described in EN 50332-1; and 		N/A

IEC60950_1B - ATTACHMENT			
Clause	Requirement + Test	Result - Remark	Verdict
(Cont.)	<p>2) a personal music player provided with an analogue electrical output socket for a listening device, the electrical output shall be ≤ 150 mV measured as described in EN 50332-2, while playing the fixed "programme simulation noise" described in EN 50332-1.</p> <p>For music where the average sound pressure (long term LAeq,T) measured over the duration of the song is lower than the average produced by the programme simulation noise, the warning does not need to be given as long as the average sound pressure of the song is below the basic limit of 85 dBA. In this case T becomes the duration of the song.</p> <p>NOTE 4 Classical music typically has an average sound pressure (long term LAeq,T) which is much lower than the average programme simulation noise. Therefore, if the player is capable to analyse the song and compare it with the programme simulation noise, the warning does not need to be given as long as the average sound pressure of the song is below the basic limit of 85 dBA.</p> <p>For example, if the player is set with the programme simulation noise to 85 dBA, but the average music level of the song is only 65 dBA, there is no need to give a warning or ask an acknowledgement as long as the average sound level of the song is not above the basic limit of 85 dBA</p>		N/A
Zx.3	<p>Warning The warning shall be placed on the equipment, or on the packaging, or in the instruction manual and shall consist of the following: the symbol of Figure 1 with a minimum height of 5 mm; and the following wording, or similar:</p> <div style="border: 1px solid black; padding: 5px; margin: 10px auto; width: fit-content;"> <p>To prevent possible hearing damage, do not listen at high volume levels for long periods.</p> </div> <div style="text-align: center; margin: 10px auto;">  </div> <p>Figure 1 – Warning label (IEC 60417-6044) Alternatively, the entire warning may be given through the equipment display during use, when the user is asked to acknowledge activation of the higher level.</p>		N/A
Zx.4	<p>Requirements for listening devices (headphones and earphones)</p>		N/A

IEC60950_1B - ATTACHMENT			
Clause	Requirement + Test	Result - Remark	Verdict
Zx.4.1	<p>Wired listening devices with analogue input With 94 dBA sound pressure output LAeq,T, the input voltage of the fixed “programme simulation noise” described in EN 50332-2 shall be ≥ 75 mV. This requirement is applicable in any mode where the headphones can operate (active or passive), including any available setting (for example built-in volume level control). NOTE The values of 94 dBA – 75 mV correspond with 85dBA – 27 mV and 100 dBA – 150 mV.</p>		N/A
Zx.4.2	<p>Wired listening devices with digital input With any playing device playing the fixed “programme simulation noise” described in EN 50332-1 (and respecting the digital interface standards, where a digital interface standard exists that specifies the equivalent acoustic level), the acoustic output LAeq,T of the listening device shall be ≤ 100 dBA. This requirement is applicable in any mode where the headphones can operate, including any available setting (for example built-in volume level control, additional sound feature like equalization, etc.). NOTE An example of a wired listening device with digital input is a USB headphone.</p>		N/A
Zx.4.3	<p>Wireless listening devices In wireless mode: with any playing and transmitting device playing the fixed programme simulation noise described in EN 50332-1; and respecting the wireless transmission standards, where an air interface standard exists that specifies the equivalent acoustic level; and with volume and sound settings in the listening device (for example built-in volume level control, additional sound feature like equalization, etc.) set to the combination of positions that maximize the measured acoustic output for the above-mentioned programme simulation noise, the acoustic output LAeq,T of the listening device shall be ≤ 100 dBA. NOTE An example of a wireless listening device is a Bluetooth headphone.</p>		N/A
Zx.5	<p>Measurement methods <i>Measurements shall be made in accordance with EN 50332-1 or EN 50332-2 as applicable. Unless stated otherwise, the time interval T shall be 30 s.</i> NOTE Test method for wireless equipment provided without listening device should be defined.</p>		N/A

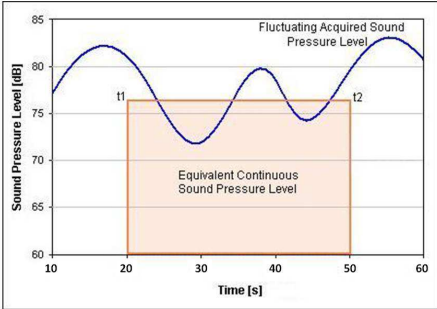
IEC60950_1B - ATTACHMENT			
Clause	Requirement + Test	Result - Remark	Verdict
Annex Zx (informative)	<p>Significance of LAeq,T in EN 50332-1 and additional information</p> <p>LAeq,T is derived from the general formula for equivalent sound pressure:</p> $L_{eq} = 10 \log \left[\frac{1}{t_2 - t_1} \int_{t_1}^{t_2} \frac{p_A^2}{p_0^2} dt \right]$ <p>This can be represented graphically as follows:</p>  <p>In EN 50332-1 the measurement time interval ($t_2 - t_1$) is 30 s.</p> <p>In practice, and for the purposes of listening to personal music player content, LAeq,T has a time interval T ($t_2 - t_1$) in the order of minutes / hours and not seconds.</p> <p>6.5 (Limitation value) of EN 50332-1:2000 acknowledges this fact and states that the 100 dB limit equates to a long time average of 90 dB LAeq,T. By using the IEC 60268-1 “programme simulation noise” test signal, this also takes the spectral content into account.</p> <p>The SCENHIR1 report states that 80 dBA is considered safe for an exposure time of 40 h/week. Most persons do not listen to 40 h/week to their personal music player. In addition, not all music tracks are at the same level of the simulated noise signal. Whilst modern music tends to be at around the same level, most of the available music is at a lower average level.</p> <p>Therefore, the working group2 considers a value of 85 dBA to be safe for an overwhelming majority of the users of personal music players.</p>		N/A

National Differences			
Clause	Requirement + Test	Result - Remark	Verdict
	National Differences Korea (KR) IEC 60950-1, 2nd ed. (K 60950-1) Last modification 2007-05-29		
1.5.101	Plugs for the connection of the apparatus to the supply mains shall comply with the Korean requirement (KSC 8305).	Shall be evaluated when subjected to national approval	N/A
7	EMC The apparatus shall comply with the relevant CISPR standards.	Shall be evaluated when subjected to national approval	N/A

National Differences			
Clause	Requirement + Test	Result - Remark	Verdict
National Differences Australia (AU) IEC 60950-1, 2nd ed. (AS/NZS 60950.1:2011) Last modification 2011-05-06			

	Appendix ZZ (Normative) Variations to IEC 60950-1:2005 for application in Australia and New Zealand		—
	ZZ1 Introduction This Appendix sets out variations and additional requirements to cover issues which have been addressed by International Standard. These variations indicate national variations for purposes of the IEC CB System and will be published in the IEC CB Bulletin.		—
	ZZ2 Variations The following variations apply to the source text:		—
1.2	Insert the following between 'person, service' and 'range, rated frequency': POTENTIAL IGNITION SOURCE.....1.2.12		P
1.2.12.201	Insert a new Clause 1.2.12.201 after Clause 1.2.12.15 as follows: 1.2.12.201 POTENTIAL IGNITION SOURCE Possible fault which can start a fire if the open-circuit voltage measured across an interruption or faulty contact exceeds a value of 50 V (peak) a.c. or d.c. and the product of the peak value of this voltage and the measured r.m.s. current under normal operating conditions exceeds 15 VA. Such a faulty contact or interruption in an electrical connection includes those which may occur in CONDUCTIVE PATTERNS on PRINTED BOARDS. NOTE 201 An electronic protection circuit may be used to prevent such a fault from becoming a POTENTIAL IGNITION SOURCE. NOTE 202 This definition is from AS/NZS 60065:2003.		P

National Differences																				
Clause	Requirement + Test	Result - Remark	Verdict																	
1.5.1	<p>Add the following to the end of first paragraph: 'or the relevant Australian/New Zealand Standard.'</p> <p>Add the following after the word 'standard', in NOTE 1: 'or the Australian/New Zealand Standard'</p>		P																	
1.5.2	<p>Add the following to the end of first and third dash items: 'or the relevant Australian/New Zealand Standard'</p>		P																	
3.2.5.1	<p>Modify Table 3B as follows:</p> <p>Delete the first four rows and replace with the following:</p> <table border="1" data-bbox="431 829 971 1182"> <thead> <tr> <th rowspan="2">RATED CURRENT OF EQUIPMENT A</th> <th colspan="2">Minimum conductor sizes</th> </tr> <tr> <th>Nominal cross-section area mm²</th> <th>AWG or Kcmil (cross-section area in mm²) See note 2</th> </tr> </thead> <tbody> <tr> <td>Over 0.2 up to and including 3</td> <td>0,5^{a)}</td> <td>18 [0,8]</td> </tr> <tr> <td>Over 3 up to and including 7.5</td> <td>0,75</td> <td>16 [1,3]</td> </tr> <tr> <td>Over 7.5 up to and including 10</td> <td>(0,75)^{b)}</td> <td>16 [1,3]</td> </tr> <tr> <td>Over 10 up to and including 16</td> <td>(1,0)^{c)}</td> <td>14 [2]</td> </tr> </tbody> </table> <p>Delete NOTE 1.</p> <p>Delete Footnote ^{a)} and Replace with the following:</p> <p>a) This nominal cross-sectional area is only allowed for Class II appliances if the length of the power supply cord, measured between the point where the cord, or cord guard, enters the appliance, and the entry to the plug does not exceed 2 m (0.5 mm² three-core supply flexible cords are not permitted; see AS/NZS 3191).</p>	RATED CURRENT OF EQUIPMENT A	Minimum conductor sizes		Nominal cross-section area mm ²	AWG or Kcmil (cross-section area in mm ²) See note 2	Over 0.2 up to and including 3	0,5 ^{a)}	18 [0,8]	Over 3 up to and including 7.5	0,75	16 [1,3]	Over 7.5 up to and including 10	(0,75) ^{b)}	16 [1,3]	Over 10 up to and including 16	(1,0) ^{c)}	14 [2]		N/A
RATED CURRENT OF EQUIPMENT A	Minimum conductor sizes																			
	Nominal cross-section area mm ²	AWG or Kcmil (cross-section area in mm ²) See note 2																		
Over 0.2 up to and including 3	0,5 ^{a)}	18 [0,8]																		
Over 3 up to and including 7.5	0,75	16 [1,3]																		
Over 7.5 up to and including 10	(0,75) ^{b)}	16 [1,3]																		
Over 10 up to and including 16	(1,0) ^{c)}	14 [2]																		
4.1.201	<p>Insert a new Clause 4.1.201 after Clause 4.1 as follows:</p> <p>4.1.201 Display devices used for television purposes Display devices which may be used for television purpose, with a mass of 7 kg or more, shall comply with the requirements for stability and mechanical hazards, including the additional stability requirements for television receivers, specified in AS/NZS 60065.</p>		N/A																	

National Differences			
Clause	Requirement + Test	Result - Remark	Verdict
4.3.6	<p>Delete the third paragraph and Replace with the following:</p> <p>Equipment with a plug portion, suitable for insertion into a 10 A 3-pin flat-pin socket-outlet complying with AS/NZS 3112, shall comply with the requirements in AS/NZS 3112 for equipment with integral pins for insertion into socket-outlets.</p>		N/A
4.3.13.5	<p>Add the following to the end of the first paragraph:</p> <p>‘, or AS/NZS 2211.1.’</p>		N/A
4.7	<p>Add the following new paragraph to the end of the clause:</p> <p>‘For alternate tests refer to Clause 4.7.201.’</p>		N/A
4.7.201	<p>Insert a new Clause 4.7.201 after Clause 4.7.3.6 as follows:</p> <p>4.7.201 Resistance to fire – Alternative tests</p>		N/A
4.7.201.1	<p>General</p> <p>Parts of non-metallic material shall be resistant to ignition and spread of fire.</p> <p>This requirement does not apply to decorative trims, knobs and other parts unlikely to be ignited or to propagate flames originating from inside the apparatus, or the following:</p> <p>(a) Components that are contained in an enclosure having a flammability category of FV-0 according to AS/NZS 60695.11.10 and having openings only for the connecting wires filling the openings completely, and for ventilation not exceeding 1 mm in width regardless of length.</p> <p>(b) The following parts which would contribute negligible fuel to a fire:</p> <ul style="list-style-type: none"> - small mechanical parts, the mass of which does not exceed 4 g, such as mounting parts, gears, cams, belts and bearings; - small electrical components, such as capacitors with a volume not exceeding 1 750 mm³, integrated circuits, transistors and optocoupler packages, if these components are mounted on material of flammability category V-1, or better, according to AS/NZS 60695.11.10. 		N/A

National Differences			
Clause	Requirement + Test	Result - Remark	Verdict
(cont.)	<p>NOTE In considering how to minimize propagation of fire and what 'small parts' are, account should be taken of the cumulative effect of small parts adjacent to each other for the possible effect of propagating fire from one part to another.</p> <p>Compliance shall be checked by the tests of 4.7.201.2, 4.7.201.3, 4.7.201.4 and 4.7.201.5.</p> <p>For the base material of printed boards, compliance shall be checked by the test of 4.7.201.5.</p> <p>The tests shall be carried out on parts of non-metallic material which have been removed from the apparatus. When the glow wire test is carried out, the parts shall be placed in the same orientation as they would be in normal use.</p> <p>These tests are not carried out on internal wiring.</p>		N/A
4.7.201.2	<p>Testing of non-metallic materials</p> <p>Parts of non-metallic material shall be subject to the glow-wire test of AS/NZS 60695.2.11 which shall be carried out at 550 °C.</p> <p>Parts for which the glow-wire test cannot be carried out, such as those made of soft or foamy material, shall meet the requirements specified in ISO 9772 for category FH-3 material. The glow-wire test shall be not carried out on parts of material classified at least FH-3 according to ISO 9772 provided that the sample tested was not thicker than the relevant part.</p>		N/A
4.7.201.3	<p>Testing of insulating materials</p> <p>Parts of insulating material supporting POTENTIAL IGNITION SOURCES shall be subject to the glow-wire test of AS/NZS 60695.2.11 which shall be carried out at 750 °C.</p> <p>The test shall be also carried out on other parts of insulating material which are within a distance of 3 mm of the connection.</p> <p>NOTE Contacts in components such as switch contacts are considered to be connections.</p>		N/A

National Differences													
Clause	Requirement + Test	Result - Remark	Verdict										
(cont.)	<p>For parts which withstand the glow-wire test but produce a flame, other parts above the connection within the envelope of a vertical cylinder having a diameter of 20 mm and a height of 50 mm shall be subjected to the needle-flame test. However, parts shielded by a barrier which meets the needle-flame test shall not be tested.</p> <p>The needle-flame test shall be made in accordance with AS/NZS 60695.11.5 with the following modifications:</p> <table border="1"> <thead> <tr> <th>Clause of AS/NZS 60695.11.5</th> <th>Change</th> </tr> </thead> <tbody> <tr> <td colspan="2">9 Test procedure</td> </tr> <tr> <td>9.2 Application of needle-flame</td> <td> <p>Replace the first paragraph with: The specimen shall be arranged so that the flame can be applied to a vertical or horizontal edge as shown in the examples of figure 1. If possible the flame shall be applied at least 10 mm from a corner.</p> <p>Replace the second paragraph with: The duration of application of the test flame shall be 30 s ± 1 s.</p> </td> </tr> <tr> <td>9.3 Number of test specimens</td> <td> <p>Replace with: The test shall be made on one specimen. If the specimen does not withstand the test, the test may be repeated on two further specimens, both of which shall withstand the test.</p> </td> </tr> <tr> <td>11 Evaluation of test results</td> <td> <p>Replace with: The duration of burning (t_b) shall not exceed 30 s. However, for printed circuit boards, it shall not exceed 15 s.</p> </td> </tr> </tbody> </table>	Clause of AS/NZS 60695.11.5	Change	9 Test procedure		9.2 Application of needle-flame	<p>Replace the first paragraph with: The specimen shall be arranged so that the flame can be applied to a vertical or horizontal edge as shown in the examples of figure 1. If possible the flame shall be applied at least 10 mm from a corner.</p> <p>Replace the second paragraph with: The duration of application of the test flame shall be 30 s ± 1 s.</p>	9.3 Number of test specimens	<p>Replace with: The test shall be made on one specimen. If the specimen does not withstand the test, the test may be repeated on two further specimens, both of which shall withstand the test.</p>	11 Evaluation of test results	<p>Replace with: The duration of burning (t_b) shall not exceed 30 s. However, for printed circuit boards, it shall not exceed 15 s.</p>		N/A
Clause of AS/NZS 60695.11.5	Change												
9 Test procedure													
9.2 Application of needle-flame	<p>Replace the first paragraph with: The specimen shall be arranged so that the flame can be applied to a vertical or horizontal edge as shown in the examples of figure 1. If possible the flame shall be applied at least 10 mm from a corner.</p> <p>Replace the second paragraph with: The duration of application of the test flame shall be 30 s ± 1 s.</p>												
9.3 Number of test specimens	<p>Replace with: The test shall be made on one specimen. If the specimen does not withstand the test, the test may be repeated on two further specimens, both of which shall withstand the test.</p>												
11 Evaluation of test results	<p>Replace with: The duration of burning (t_b) shall not exceed 30 s. However, for printed circuit boards, it shall not exceed 15 s.</p>												
(cont.)	<p>The needle-flame test shall not be carried out on parts of material classified as V-0 or V-1 according to AS/NZS 60695.11.10, provided that the sample tested was not thicker than the relevant part.</p>												

National Differences			
Clause	Requirement + Test	Result - Remark	Verdict
4.7.201.4	<p>Testing in the event of non-extinguishing material</p> <p>If parts, other than enclosures, do not withstand the glow wire tests of 4.7.201.3, by failure to extinguish within 30 s after the removal of the glow-wire tip, the needle-flame test detailed in 4.7.201.3 shall be made on all parts of non-metallic material which are within a distance of 50 mm or which are likely to be impinged upon by flame during the tests of 4.7.201.3. Parts shielded by a separate barrier which meets the needle-flame test need not be tested.</p> <p>NOTE 1 If the enclosure does not withstand the glow-wire test the equipment is considered to have failed to meet the requirements of Clause 4.7.201 without the need for consequential testing.</p> <p>NOTE 2 If other parts do not withstand the glow-wire test due to ignition of the tissue paper and if this indicates that burning or glowing particles can fall onto an external surface underneath the equipment, the equipment is considered to have failed to meet the requirements of Clause 4.7.201 without the need for consequential testing.</p> <p>NOTE 3 Parts likely to be impinged upon by the flame are considered to be those within the envelope of a vertical cylinder having a radius of 10 mm and a height equal to the height of the flame, positioned above the point of the material supporting, in contact with, or in close proximity to, connections.</p>		N/A

National Differences			
Clause	Requirement + Test	Result - Remark	Verdict
4.7.201.5	<p>Testing of printed board</p> <p>The base material of printed boards shall be subjected to the needle-flame test of Clause 4.7.201.3. The flame shall be applied to the edge of the board where the heat sink effect is lowest when the board is positioned as in normal use. The flame shall not be applied to an edge, consisting of broken perforations, unless the edge is less than 3 mm from a POTENTIAL IGNITION SOURCE.</p> <p>The test is not carried out if the —</p> <ul style="list-style-type: none"> - Printed board does not carry any POTENTIAL IGNITION SOURCE; - Base material of printed boards, on which the available apparent power at a connection exceeds 15 VA operating at a voltage exceeding 50 V and equal or less than 400 V (peak) a.c. or d.c. under normal operating conditions, is of flammability category V-1 or better according to AS/NZS 60695.11.10, or the printed boards are protected by an enclosure meeting the flammability category V-0 according to AS/NZS 60695.11.10, or made of metal, having openings only for connecting wires which fill the openings completely; or - Base material of printed boards, on which the available apparatus power at a connection exceeds 15 VA operating at a voltage exceeding 400 V (peak) a.c. or d.c. under normal operating conditions, and base material of printed boards supporting spark gaps which provides protection against overvoltages, is of flammability category V-0 according to AS/NZS 60695.11.10 or the printed boards are contained in a metal enclosure, having openings only for connecting wires which fill the openings completely. <p>Compliance shall be determined using the smallest thickness of the material.</p> <p>NOTE – Available apparent power is the maximum apparent power which can be drawn from the supplying circuit through a resistive load whose value is chosen to maximise the apparent power for more than 2 min when the circuit supplied is disconnected.</p>		N/A
6.2.2	<p>For Australia only, delete the first paragraph and Note, and replace with the following:</p> <p>In Australia only, compliance with 6.2.2 shall be checked by the tests of both 6.2.2.1 and 6.2.2.2.</p>		N/A

National Differences			
Clause	Requirement + Test	Result - Remark	Verdict
6.2.2.1	<p>For Australia only, delete the first paragraph including the Notes, and replace with the following:</p> <p>In Australia only, the electrical separation is subjected to 10 impulses of alternating polarity, using the impulse test generator reference 1 of Table N.1. The interval between successive impulses is 60 s and the initial voltage, U_c, is:</p> <p>(i) for 6.2.1 a): 7.0 kV for hand-held telephones and for headsets and 2.5 kV for other equipment; and</p> <p>(ii) for 6.2.1 b) and 6.2.1 c): 1.5 kV.</p> <p>NOTE 201 The 7 kV impulse simulates lightning surges on typical rural and semi-rural network lines.</p> <p>NOTE 202 The value of 2.5 kV for 6.2.1 a) was chosen to ensure the adequacy of the insulation concerned and does not necessarily simulate likely overvoltages.</p>		N/A
6.2.2.2	<p>For Australia only, delete the second paragraph including the Note, and replace with the following:</p> <p>In Australia only, the a.c. test voltage is:</p> <p>(i) for 6.2.1 a): 3 kV; and</p> <p>(ii) for 6.2.1 b) and 6.2.1 c): 1.5 kV.</p> <p>NOTE 201 Where there are capacitors across the insulation under test, it is recommended that d.c. test voltages are used.</p> <p>NOTE 202 The 3 kV and 1.5 kV values have been determined considering the low frequency induced voltages from the power supply distribution system.</p>		N/A
7.3	<p>Add the following before the first paragraph:</p> <p>Equipment providing functions that fall only within the scope of AS/NZS 60065 and that incorporate a PSTN interface, are not required to comply with this clause where the only ports provided on the equipment, in addition to a coaxial cable connection and a PSTN interface, are audio or video ports and analogue or data ports not intended to be used for telecommunications purposes.</p>		N/A
Annex P	<p>Add the following Normative References:</p> <p>AS/NZS 3191, Electric flexible cords</p> <p>AS/NZS 3112, Approval and test specification—Plugs and socket-outlets</p>		N/A



National Differences			
Clause	Requirement + Test	Result - Remark	Verdict
Index	<p>Insert the following between 'asbestos, not to be used as insulation' and 'attitude see orientation':</p> <p>AS/NZS 2211.1.....4.3.13.5 AS/NZS 31124.3.6 AS/NZS 3191.....3.2.5.1 (Table 3B) AS/NZS 60065.....4.1.201 AS/NZS 60695.2.11.....4.7.201.2, 4.7.201.3 AS/NZS 60695.11.10.....4.7.201.1, 4.7.201.5 AS/NZS 60950.11.5.....4.7.201.3</p> <p>Insert the following between 'positive temperature coefficient (PTC) device' and 'powder': potential ignition source.....1.2.201, 4.7.201.3, 4.7.201.5</p>		N/A

National Differences			
Clause	Requirement + Test	Result - Remark	Verdict
National Differences China (CN) IEC 60950, 3rd ed.			

	<p>1. Supply tolerance</p> <p>Item 1.4.5 of IEC 60950 stipulates the tolerance of rated voltage is +6 % and -10 %, while GB4943-2001 makes a specification of tolerance of +10 % and -10 %.</p>		P
	<p>2. Power rating marking</p> <p>Item 1.7.1 of IEC 60950 does not specify concrete figures of markings of supply voltage and frequency, instead, descriptions are given by examples. But the examples do not include China's mains voltage. GB4943-2001 stipulates that:</p> <ul style="list-style-type: none"> - A single rated voltage shall expressed as 220 V - When a rated voltage range is given, the range shall cover 220 V - When a variety voltages or rated voltage ranges are given, one of them shall be set as 220 V when dispatched from the factory - Rated frequency or rated frequency range shall be 50 Hz or include 50 Hz - If a unit is not provided with means of direct connection to the AC mains supply, it need not be marked with any electrical rating 		P
	<p>3. Plate and warning marking in Chinese</p> <p>Item 1.7.12 of GB4943-2001 stipulates: instructions and equipment markings related to safety shall be in standardized Chinese.</p>		N/A
	<p>4. Power supply plug</p> <p>According to China's particular standard for power supply plug, it is added in article 3.2.1 of GB4943-2001 that plug connecting equipment with AC mains supply shall be in accordance with requirements of GB1002.</p>		N/A

National Differences			
Clause	Requirement + Test	Result - Remark	Verdict
National Differences Japan (JP) IEC 60950-1, 1st ed. (J60950-1 (H22)) Last modification 2010-11-27			

1.2.4.1	Add the following new notes: Note: Even if the equipment is designed as Class I, the equipment is regarded as Class 0I equipment when 2-pin adaptor with earthing lead wire or cord set having 2-pin plug with earthing lead wire is provided or recommended.	The EUT is Class II equipment	N/A
1.2.4.3A	Add the following new clause: 1.2.4.3A CLASS 0I EQUIPMENT Equipment having attachment plug without earthing blade, where protection against electric shock is achieved by: - using BASIC INSULATION, and - providing externally an earth terminal or a lead wire for earthing in order to connect those conductive parts that might assume a HAZARDOUS VOLTAGES in the event of BASIC INSULATION fault to the PROTECTIVE EARTHING CONDUCTOR in the building wiring. NOTE – Class 0I equipment may have a part constructed with Double Insulation or Reinforced Insulation circuit.	The EUT is Class II equipment	N/A
1.3.2	Add the following notes after first paragraph: Note 1: Transportable or similar equipment that are relocated frequently for intended usage should not be designed as Class I or Class 0I equipment unless it is intended to be installed by service personnel. Note 2: Considering wiring circumstance in Japan, equipment intended to be installed where the provision for earthing connection is unlikely should not be designed as Class I or Class 0I equipment unless it is intended to be installed by service personnel.	The EUT is Class II equipment	N/A

National Differences			
Clause	Requirement + Test	Result - Remark	Verdict
1.5.1	<p>Replace the first paragraph with the follows:</p> <p>Where safety is involved, components shall comply either with the requirements of this standard, with the safety aspects of the relevant JIS component standard, or IEC component standards in case there is no applicable JIS component standard is available. However, a component that falls within the scope of METI Ministerial ordinance No. 85 is properly used in accordance with its marked ratings, requirements of 1.5.4, 2.8.7 and 3.2.5 apply, and in addition, a cord connector of power supply cord set mating with appliance inlet complying with the standard sheet of IEC 60320-1, shall comply with relevant standard sheet of IEC 60320-1.</p> <p>Replace Note 1 with the following:</p> <p>Note 1: A JIS or an IEC component standard is considered relevant only if the component in question clearly falls within its scope.</p>	Added	P
1.5.2	<p>Replace first sentence in the first dashed paragraph with the following:</p> <p>a component that has been demonstrated to comply with a JIS component standard harmonized with the relevant IEC component standard, or where such JIS component standard is not available, a component that has been demonstrated to comply with the relevant IEC component standard shall be checked for correct application and use in accordance with its rating.</p> <p>Add a note after the first dashed paragraph as follows:</p> <p>Note 1: See 1.7.5A when Type C.14 appliance coupler rated 10 A per IEC 60320-1 is used with an equipment rated not more than 125 V and rated more than 10 A.</p>	Added	P
(cont.)	<p>Replace first sentence in the third dashed paragraph as follows:</p> <p>where no relevant IEC component standard or JIS component standard harmonized with the relevant IEC component standard exists, or where components are used in circuits not in accordance with their specified rating, the components shall be tested under the conditions occurring in the equipment.</p>	Added	P
1.7.1	<p>Replace fifth dashed paragraph with the following:</p> <p>- manufacturer's or responsible company's name or trade-mark or identification mark;</p>	Added	P

National Differences			
Clause	Requirement + Test	Result - Remark	Verdict
1.7.5A	<p>Add the following new clause. after 1.7.5:</p> <p>1.7.5A Appliance Coupler</p> <p>If appliance coupler according to IEC60320-1, C.14(rated current: 10A)is used in equipment whose rated voltage is less than 125V and rated current is over 10A, the following instruction or equivalent shall be described in the user instruction.</p> <p>“ Use only designated cord set attached in this equipment”</p>		N/A
1.7.12	<p>Replace first sentence with the following:</p> <p>Instructions and equipment marking related to safety shall be in Japanese.</p>	Shall be evaluated when subjected to national approval	N/A
1.7.17A	<p>Add the following new clause. after 1.7.17:</p> <p>1.7.17A Marking for CLASS 0I EQUIPMENT</p> <p>For CLASS 0I EQUIPMENT, the following instruction shall be marked on the visible place of the mains plug or the main body:</p> <p>“Provide an earthing connection”</p> <p>Moreover, for CLASS 0I EQUIPMENT, the following or equivalent instruction shall be indicated on the visible place of the main body or written in the operating instructions:</p> <p>“Provide an earthing connection before the mains plug is connected to the mains. And, when disconnecting the earthing connection, be sure to disconnect after pulling out the mains plug from the mains.”</p>		N/A
2.6.3.2	<p>Add the following after 1st paragraph:</p> <p>This also applies to the conductor of lead wire for protective earthing of CLASS 0I EQUIPMENT.</p>		N/A
2.6.4.2	<p>Replace 1st paragraph with the following:</p> <p>Equipment required to have protective earthing shall have a main protective earthing terminal.</p> <p>For equipment with a DETACHABLE POWER SUPPLY CORD, the earthing terminal in the appliance inlet is regarded as the main protective earthing terminal except for CLASS 0I EQUIPMENT providing separate main protective earthing terminal other than appliance inlet.</p>		N/A

National Differences			
Clause	Requirement + Test	Result - Remark	Verdict
2.6.5.4	<p>Replace 1st sentence with the following: Protective earthing connections of CLASS I EQUIPMENT shall make earlier and break later than the supply connections in each of the following:</p>		N/A
2.6.5.8A	<p>Add the following new clause. after 2.6.5.8A: 2.6.5.8A Earthing of CLASS 0I EQUIPMENT Plugs with a lead wire for earthing shall not be used for equipment having a rated voltage exceeding 150V. For plugs with a lead wire for earthing, the lead wire shall not be earthed by a clip. CLASS 0I EQUIPMENT shall be provided with an earthing terminal or lead wire for earthing in the external location where easily visible.</p>		N/A
3.2.3	<p>Add the following after Table 3A: Table 3A applies when cables complying JIS C 3662 or JIS C 3663 are used. In case of other cables, cable entries shall be so designed that a conduit suitable for the cable used can be fitted.</p>		N/A
3.2.5.1	<p>Add the following to the last of first dashed paragraph: Or mains cords shall be of the sheathed type complying with Appendix 1 of Article 1 of the Ministerial Ordinance on stipulating technical requirements for the Electrical Appliance. Add the following to the last of second dashed paragraph. Or mains cords shall be of the sheathed type complying with Appendix 1 of Article 1 of the Ministerial Ordinance on stipulating technical requirements for the Electrical Appliance. Delete 1) in Table 3B.</p>		N/A
3.3.4	<p>Add the following note to Table 3D: Note: For cables other than those complying with JIS C 3662 or JIS C 3663, terminals shall be suitable for the size of the intended cables.</p>		N/A
3.3.7	<p>Add the following after the first sentence: This requirement is not applicable to the external earthing terminal of Class 0I equipment.</p>		N/A

National Differences																																
Clause	Requirement + Test	Result - Remark	Verdict																													
4.3.4	<p>Add the following after the first sentence:</p> <p>This requirement also applies to those connections in Class 0I equipment, where CLEARANCE or CREEPAGE DISTANCES over BASIC INSULATION would be reduced to less than the values specified in 2.10.</p>		N/A																													
5.1.3	<p>Add a note after the first paragraph as follows:</p> <p>Note – Attention should be drawn to that majority of three-phase power system in Japan is of delta connection, and therefore, in that case, test is conducted using the test circuit from IEC 60990, figure 13.</p>		N/A																													
5.1.6	<p>Replace Table 5A. as follows:</p> <table border="1"> <thead> <tr> <th>Type of equipment</th> <th>Terminal A of measuring instrument connected to:</th> <th>Maximum TOUCH CURRENT mA r.m.s.¹⁾</th> <th>Maximum PROTECTIVE CONDUCTOR CURRENT</th> </tr> </thead> <tbody> <tr> <td>ALL equipment</td> <td>Accessible parts and circuits not connected to protective earth</td> <td>0,25</td> <td>-</td> </tr> <tr> <td>HAND-HELD</td> <td rowspan="4">Equipment main protective earthing terminal (if any) CLASS I EQUIPMENT</td> <td>0,75</td> <td>-</td> </tr> <tr> <td>MOVABLE (other than HAND-HELD, but including TRANS-PORTABLE EQUIPMENT)</td> <td>3,5</td> <td>-</td> </tr> <tr> <td>STATIONARY, PLUGGABLE TYPE A</td> <td>3,5</td> <td>-</td> </tr> <tr> <td>ALL other STATIONARY EQUIPMENT - not subject to the conditions of 5.1.7 - subject to the conditions of 5.1.7</td> <td>3,5</td> <td>-</td> </tr> <tr> <td>HAND-HELD</td> <td>Equipment main</td> <td>0,5</td> <td>-</td> </tr> <tr> <td>Others</td> <td>protective earthing terminal (if any) CLASS 0I EQUIPMENT</td> <td>1,0</td> <td>-</td> </tr> </tbody> </table> <p>¹⁾ If peak values of TOUCH-CURRENT are measured, the maximum values obtained by multiplying the r.m.s. values by 1,414.</p>	Type of equipment	Terminal A of measuring instrument connected to:	Maximum TOUCH CURRENT mA r.m.s. ¹⁾	Maximum PROTECTIVE CONDUCTOR CURRENT	ALL equipment	Accessible parts and circuits not connected to protective earth	0,25	-	HAND-HELD	Equipment main protective earthing terminal (if any) CLASS I EQUIPMENT	0,75	-	MOVABLE (other than HAND-HELD, but including TRANS-PORTABLE EQUIPMENT)	3,5	-	STATIONARY, PLUGGABLE TYPE A	3,5	-	ALL other STATIONARY EQUIPMENT - not subject to the conditions of 5.1.7 - subject to the conditions of 5.1.7	3,5	-	HAND-HELD	Equipment main	0,5	-	Others	protective earthing terminal (if any) CLASS 0I EQUIPMENT	1,0	-		P
Type of equipment	Terminal A of measuring instrument connected to:	Maximum TOUCH CURRENT mA r.m.s. ¹⁾	Maximum PROTECTIVE CONDUCTOR CURRENT																													
ALL equipment	Accessible parts and circuits not connected to protective earth	0,25	-																													
HAND-HELD	Equipment main protective earthing terminal (if any) CLASS I EQUIPMENT	0,75	-																													
MOVABLE (other than HAND-HELD, but including TRANS-PORTABLE EQUIPMENT)		3,5	-																													
STATIONARY, PLUGGABLE TYPE A		3,5	-																													
ALL other STATIONARY EQUIPMENT - not subject to the conditions of 5.1.7 - subject to the conditions of 5.1.7		3,5	-																													
HAND-HELD	Equipment main	0,5	-																													
Others	protective earthing terminal (if any) CLASS 0I EQUIPMENT	1,0	-																													

National Differences			
Clause	Requirement + Test	Result - Remark	Verdict
7.2	<p>Add the following after the paragraph:</p> <p>However, the separation requirements and tests of 6.2.1 a), b) and c) do not apply to a CABLE DISTRIBUTION SYSTEM if all of the following apply:</p> <ul style="list-style-type: none"> – the circuit under consideration is a TNV-1 CIRCUIT; and – the common or earthed side of the circuit is connected to the screen of the coaxial cable and to all accessible parts and circuits (SELV, accessible metal parts and LIMITED CURRENT CIRCUITS, if any); and – the screen of the coaxial cable is intended to be connected to earth in the building installation. 		N/A
W.1	<p>Replace second and third sentence in the first paragraph with the following:</p> <p>This distinction between earthed and unearthed (floating) circuit is not the same as between CLASS I EQUIPMENT, CLASS 0I EQUIPMENT and CLASS II EQUIPMENT. Floating circuits can exist in CLASS I EQUIPMENT or CLASS 0I EQUIPMENT and earthed circuits in CLASS II EQUIPMENT.</p>		N/A
Annex JA	<p>Add a new annex JA with the following contents:</p> <p style="text-align: center;">Annex JA (normative) Document shredding machines</p> <p>Document shredding machines shall also comply with the requirements of this annex except those of STATIONARY EQUIPMENT used by connecting directly to an AC MAINS SUPPLY of three-phase 200V or more.</p> <p>JA.1 Markings and instructions</p> <p>The symbol</p> <p> (JIS S 0101:2000, 6.2.4) and the following precautions for use shall be marked on readily visible part adjacent to document feed opening. The marking shall be clearly legible, permanent, and easily discernible;</p> <ul style="list-style-type: none"> - that use by an infants/children may cause a hazard of injury etc.; 		N/A

National Differences			
Clause	Requirement + Test	Result - Remark	Verdict
(cont.)	<p>- that a hand can be drawn into the mechanical section for shredding when touching the document-slot;</p> <p>- that clothing can be drawn into the mechanical section for shredding when touching the document-slot;</p> <p>- that hairs can be drawn into the mechanical section for shredding when touching the document-slot;</p> <p>- in case of equipment incorporating a commutator motor, that equipment may catch fire or explode by spraying of flammable gas.</p> <p>JA.2 Inadvertent reactivation</p> <p>Any safety interlock that can be operated by means of the test finger, Figure JA.1, is considered to be likely to cause inadvertent reactivation of the hazard.</p> <p>Compliance is checked by inspection and, where necessary, by a test with the test finger, Figure JA.1</p> <p>JA.3 Disconnection from the mains supply</p> <p>Document shredding machines shall incorporate an isolating switch complying with sub-clause 3.4.2 as the device disconnecting the power of hazardous moving parts. For this switch, two-position (single-use) switch or multi-position (multifunction) switch (e.g., slide switch) may be used.</p> <p>If two-position switch, the positions for "ON" and "OFF" shall be indicated in accordance with sub-clause 1.7.8. If multi-position switch, the position for "OFF" shall be indicated in accordance with sub-clause 1.7.8 and other positions shall be indicated with proper terms or symbols.</p> <p>Compliance is checked by inspection</p> <p>JA.4 Protection against hazardous moving parts</p> <p>Any warning shall not be used instead of the structure for preventing access to hazardous moving parts.</p> <p>Document shredding machines shall comply with the following requirements.</p>		N/A

National Differences			
Clause	Requirement + Test	Result - Remark	Verdict
(cont.)	<p>Insert the test finger, Figure JA.1, into all openings in MECHANICAL ENCLOSURES without applying appreciable force. It shall not be possible to touch hazardous moving parts with the test finger. This consideration applies to all sides of MECHANICAL ENCLOSURES when the equipment is mounted as intended. Before testing with the test finger, remove the parts detachable without a tool.</p> <p>Insert the wedge-probe, Figure JA.2, into the document-slot. And, against all directions of openings, if straight-cutting type, a force of 45 N shall apply to the probe, and 90 N if cross-cutting type. In this case, the weight of the probe is to be factored into the overall applied force. Before testing with the wedge-probe, remove the parts detachable without a tool. It shall not be possible to touch any hazardous moving parts, including the shredding roller or the mechanical section for shedding, with the probe.</p>		N/A

Figure JA.1 Test finger

National Differences											
Clause	Requirement + Test	Result - Remark	Verdict								
(cont.)	<p>(Details of the tip of wedge)</p> <table border="1"> <thead> <tr> <th>Distance from the tip (mm)</th> <th>Thickness of probe (mm)</th> </tr> </thead> <tbody> <tr> <td>0</td> <td>2</td> </tr> <tr> <td>12</td> <td>4</td> </tr> <tr> <td>180</td> <td>24</td> </tr> </tbody> </table> <p>Note 1 - The thickness of the probe varies linearly, with slope changes at the respective points shown in the table.</p> <p>Note 2 - The allowable dimensional tolerance of the probe is +/- 0.127 mm.</p> <p>Figure JA.2 Wedge-probe</p>	Distance from the tip (mm)	Thickness of probe (mm)	0	2	12	4	180	24		N/A
Distance from the tip (mm)	Thickness of probe (mm)										
0	2										
12	4										
180	24										

National Differences			
Clause	Requirement + Test	Result - Remark	Verdict
National Differences Japan (JP) Special National conditions, National deviation and other information according to METI Ordinance No. 85. (J3000 (H21)) Last modification 2010-09-01			
1	General requirement When equipment provides with appliance inlet complying with JIS-C 8283-1(2008), soldered parts of appliance inlet is not applied by force during insert or removal of connector. This is not applied when inlet body is fixed itself and not fixed by solder.		P
2	Requirement for equipment		N/A
2.1	Electric heater When diode is used in parallel for adjustment of power, the equipment shall remain safe for operation under open condition of one diode.		N/A
	The current rating of one diode shall be more than main current. The diodes connected in parallel are same type.		N/A
	The heating test specified by clause 11 of JIS C 9335-2-30(2006) under open condition of one diode shall comply with the requirements.		N/A
2.2	Electric heater with glowing heating elements		N/A
	Surface treatment by paint or adhesive on protective frame or protective mesh shall not be used.		N/A
	Caution marking like below shall be on - easily visible place of the equipment or - Instruction manual 「注意当該機器から、使用初期段階で揮発性有機化合物及びカルボニル化合物が最も放散するおそれがあるため、その際には十分換気を行うこと。」		N/A

National Differences			
Clause	Requirement + Test	Result - Remark	Verdict

National Differences Canada (CA) IEC 60950-1, 2nd ed. + A1 (CAN/CSA-C22.2 No 60950-1-07, Amendment 1) Last modification 2012-02-14			
--	--	--	--

	Canada and the United States of America have adopted a single, bi-national standard, CAN/CSA C22.2 No. 60950-1/UL60950-1, Second Edition, which is based on IEC 60950-1, Second Edition. This bi-national standard should be consulted for further details on the national conditions and differences summarized below.		—
	SPECIAL NATIONAL CONDITIONS		—
	The following is a summary of the key national differences based on national regulatory requirements, such as the Canadian Electrical Code (CEC) Part I and the Canadian Building Code, which are referenced in legislation and which form the basis for the rules and practices followed in electrical and building installations.		—
Sub-Clause	National Condition		—
1.1.1	All equipment is to be designed to allow installation in accordance with the National Electrical Code (NEC), ANSI/NFPA 70, the Canadian Electrical Code (CEC), Part I, CAN/CSA C22.1, and when applicable, the National Electrical Safety Code, IEEE C2. Also, unless marked or otherwise identified, installation is allowed per the Standard for the Protection of Electronic Computer/Data-Processing Equipment, ANSI/NFPA 75.		P
1.4.14	For Pluggable Equipment Type A, the protection in the installation is assumed to be 20 A.		P
1.5.5	For lengths exceeding 3.05 m, external interconnecting flexible cord and cable assemblies are required to be a suitable cable type (e.g., DP, CL2) specified in the CEC/NEC. For lengths 3.05 m or less, external interconnecting flexible cord and cable assemblies that are not types specified in the CEC are required to have special construction features and identification markings.		P



National Differences			
Clause	Requirement + Test	Result - Remark	Verdict
1.7.1	<p>Equipment for use on a.c. mains supply systems with a neutral and more than one phase conductor (e.g. 120/240 V, 3-wire) require a special marking format for electrical ratings.</p> <p>A voltage rating that exceeds an attachment plug cap rating is only permitted if it does not exceed the extreme operating conditions in Table 2 of CAN/CSA C22.2 No. 235, and if it is part of a range that extends into the Table 2 "Normal Operating Conditions." Likewise, a voltage rating shall not be lower than the specified "Normal Operating Conditions," unless it is part of a range that extends into the "Normal Operating Conditions."</p>		N/A
1.7.7	Wiring terminals intended to supply Class 2 outputs in accordance with CEC Part 1 or NEC shall be marked with the voltage rating and "Class 2" or equivalent. Marking shall be located adjacent to the terminals and shall be visible during wiring.		N/A
2.5	Where a fuse is used to provide Class 2, Limited Power Source, or TNV current limiting, it shall not be operator-accessible unless it is not interchangeable.		N/A
2.6.3.3	The first column on Table 2D modified to require, "Smaller of the RATED CURRENT of the equipment or the PROTECTIVE CURRENT RATING of the circuit under consideration."		N/A
2.7.1	<p>Suitable NEC/CEC branch circuit protection rated at the maximum circuit rating is required for all standard supply outlets and receptacles (such as supplied in power distribution units) if the supply branch circuit protection is not suitable.</p> <p>Power distribution transformers distributing power at 100 volts or more, and rated 10 kVA or more, require special transformer overcurrent protection.</p>	Considered	P
3.2	Wiring methods (terminals, leads, etc.) used for the connection of the equipment to the mains shall be in accordance with the NEC/CEC.		N/A
3.2.1	Power supply cords are required to have attachment plugs rated not less than 125 percent of the rated current of the equipment.		N/A
3.2.1.2	Equipment connected to a centralized d.c. power system, and having one pole of the DC mains input terminal connected to the main protective earthing terminal in the equipment, is required to comply with special earthing, wiring, marking and installation instruction requirements.		N/A

National Differences			
Clause	Requirement + Test	Result - Remark	Verdict
3.2.3	Permanent connection of equipment to the mains supply by a power supply cord is not permitted, except for certain equipment, such as ATMs.	The EUT is not such equipment	N/A
3.2.5	Power supply cords are required to be no longer than 4.5 m in length Minimum cord length is required to be 1.5 m, with certain constructions such as external power supplies allowed to consider both input and output cord lengths into the requirement. Flexible power supply cords are required to be compatible with Article 400 of the NEC, and Tables 11 and 12 of the CEC.		N/A
3.2.9	Permanently connected equipment is required to have a suitable wiring compartment and wire bending space.	The EUT is not such equipment	N/A
3.3	Wiring terminals and associated spacings for field wiring connections shall comply with CSA C22.2 No. 0.	No wiring terminal	N/A
3.3.3	Wire binding screws are not permitted to attach conductors larger than 10 AWG (5.3 mm ²).		N/A
3.3.4	Terminals for permanent wiring, including protective earthing terminals, are required to be suitable for Canadian/U.S. wire gauge sizes, rated 125 percent of the equipment rating, and be specially marked when specified (1.7.7).		N/A
3.3.5	First column of Table 3E revised to require "Smaller of the RATED CURRENT of the equipment or the PROTECTIVE CURRENT RATING of the circuit under consideration."		N/A
3.4.2	Motor control devices are required for cord-connected equipment with a motor if the equipment is rated more than 12 A, or if the motor has a nominal voltage rating greater than 120 V, or is rated more than 1/3 hp (locked rotor current over 43 A).	No such device	N/A
3.4.8	Vertically-mounted disconnect switches and circuit breakers are required to have the "on" position indicated by the handle in the up position.	No such device	N/A
3.4.11	For computer room applications, equipment with battery systems capable of supplying 750 VA for five minutes are required to have a battery disconnect means that may be connected to the computer room remote power-off circuit.		N/A
4.3.12	The maximum quantity of flammable liquid stored in equipment is required to comply with NFPA 30.	No such material within the EUT	N/A

National Differences			
Clause	Requirement + Test	Result - Remark	Verdict
4.3.13.5	Equipment with lasers is required to meet the Canadian Radiation Emitting Devices Act, REDR C1370 and/or Code of Federal Regulations 21 CFR 1040, as applicable.		N/A
4.7	For computer room applications, automated information storage systems with combustible media greater than 0.76 m ³ (27 cu ft) are required to have a provision for connection of either automatic sprinklers or a gaseous agent extinguishing system with an extended discharge.		N/A
4.7.3.1	For computer room applications, enclosures with combustible material measuring greater than 0.9 m ² (10 sq ft) or a single dimension greater than 1.8 m (6 ft) are required to have a flame spread rating of 50 or less. For other applications, enclosures with the same dimensions require a flame spread rating of 200 or less.		N/A
Annex H	Equipment that produces ionizing radiation is required to comply with the Canadian Radiation Emitting Devices Act, REDR C1370 and/or Code of Federal Regulations, 21 CFR 1020, as applicable.	The EUT does not produce ionizing radiation	N/A
	OTHER DIFFERENCES		—
	The following key national differences are based on requirements other than national regulatory requirements.		—
Sub-Clause	National Difference		—

National Differences			
Clause	Requirement + Test	Result - Remark	Verdict
1.5.1	<p>Some components and materials associated with the risk of fire, electric shock, or personal injury are required to have component or material ratings in accordance with the applicable national (Canadian and/or U.S.) component or material standard requirements. These components include:</p> <p>attachment plugs, battery packs (rechargeable type, used with transportable equipment), cathode ray tubes, circuit breakers, communication circuit accessories, connectors (used for current interruption of non-LPS circuits), cord sets and power supply cords, direct plug-in equipment, enclosures (outdoor), flexible cords and cables, fuses (branch circuit), fuseholders, ground-fault current interrupters, industrial control equipment, insulating tape, interconnecting cables, lampholders, limit controls, printed wiring, protectors for communications circuits, receptacles, solid state controls, supplementary protectors, switches (including interlock switches), thermal cutoffs, thermostats, (multi-layer) transformer winding wire, transient voltage surge suppressors, tubing, wire connectors, and wire and cables.</p>		P
1.6.1.2	<p>A circuit for connection to the DC Mains Supply is classified as either a SELV Circuit, TNV-2 Circuit or Hazardous Voltage Circuit depending on the maximum operating voltage of the supply. This maximum operating voltage shall include consideration of the battery charging “float voltage” associated with the intended supply system, regardless of the marked power rating of the equipment.</p>		N/A
2.3.1	<p>For TNV-2 and TNV-3 circuits with other than ringing signals and with voltages exceeding 42.4 V_{peak} or 60 V_{d.c.}, the maximum acceptable current through a 2000 ohm resistor (or greater) connected across the voltage source with other loads disconnected is 7.1 mA peak or 30 mA d.c. under normal operating conditions.</p>	No TNV circuit within the EUT	N/A
2.3.2.1	<p>In the event of a single fault between TNV and SELV circuits, the limits of 2.2.3 apply to SELV Circuits and accessible conductive parts.</p>		N/A
2.6.3.4	<p>Protective bonding conductors of non-standard protective bonding constructions (e.g., printed circuit traces) may be subjected to the additional limited short circuit test conditions specified.</p>		N/A
4.2.8.1	<p>Enclosures around CRTs with a face diameter of 160 mm or more are required to reduce the risk of injury due to the implosion of the CRT.</p>	No such device within the EUT	N/A

National Differences			
Clause	Requirement + Test	Result - Remark	Verdict
4.3.2	Equipment with handles is required to comply with special loading tests.	No such devices within the EUT	N/A
5.1.8.3	Equipment intended to receive telecommunication ringing signals is required to comply with a special touch current measurement tests.	No TNV circuit within the EUT	N/A
5.3.7	Internal (e.g., card cage) SELV circuit connectors and printed wiring board connectors that are accessible to the operator and that deliver power are to be overloaded. During abnormal operating testing, if a circuit is interrupted by the opening of a component, the test shall be repeated twice (three tests total) using new components as necessary.		N/A
6.4	Equipment intended for connection to telecommunication network outside plant cable is required to be protected against overvoltage from power line crosses in accordance with 6.4 and Annex NAC.		N/A
M.2	Continuous ringing signals up to 16 mA only are permitted if the equipment is subjected to special installation and performance restrictions.	No TNV circuit within the EUT	N/A
Annex NAD	Equipment connected to a telecommunication and cable distribution networks and supplied with an earphone intended to be held against, or in the ear is required to comply with special acoustic pressure requirements.		N/A

National Differences			
Clause	Requirement + Test	Result - Remark	Verdict

National Differences United States of America (US) IEC 60950-1, 2nd ed. + A1 (UL 60950-1, Second Edition, Amendment 1) Last modification 2012-01-29			
---	--	--	--

	<p>The United States of America and Canada have adopted a single, bi-national standard, CAN/CSA C22.2 No. 60950-1/UL60950-1, Second Edition, which is based on IEC 60950-1, Second Edition.</p> <p>This bi-national standard should be consulted for further details on the national conditions and differences summarized below.</p>		—
	SPECIAL NATIONAL CONDITIONS		—
	The following is a summary of the key national differences based on federal regulations.		—
Sub-Clause	National Condition		—
1.1.1	All equipment is to be designed to allow installation in accordance with the National Electrical Code (NEC), ANSI/NFPA 70, the Canadian Electrical Code (CEC), Part I, CAN/CSA C22.1, and when applicable, the National Electrical Safety Code, IEEE C2. Also, unless marked or otherwise identified, installation is allowed per the Standard for the Protection of Electronic Computer/Data-Processing Equipment, ANSI/NFPA 75.		P
1.4.14	For Pluggable Equipment Type A, the protection in the installation is assumed to be 20 A.		P
1.5.5	<p>For lengths exceeding 3.05 m, external interconnecting flexible cord and cable assemblies are required to be a suitable cable type (e.g., DP, CL2) specified in the NEC.</p> <p>For lengths 3.05 m or less, external interconnecting flexible cord and cable assemblies that are not types specified in the NEC are required to have special construction features and identification markings.</p>		P



National Differences			
Clause	Requirement + Test	Result - Remark	Verdict
1.7.1	<p>Equipment for use on a.c. mains supply systems with a neutral and more than one phase conductor (e.g. 120/240 V, 3-wire) require a special marking format for electrical ratings.</p> <p>A voltage rating that exceeds an attachment plug cap rating is only permitted if it does not exceed the extreme operating conditions in Table 2 of CAN/CSA C22.2 No. 235, and if it is part of a range that extends into the Table 2 "Normal Operating Conditions." Likewise, a voltage rating shall not be lower than the specified "Normal Operating Conditions," unless it is part of a range that extends into the "Normal Operating Conditions."</p>		N/A
1.7.7	Wiring terminals intended to supply Class 2 outputs in accordance with the NEC or CEC Part 1 shall be marked with the voltage rating and "Class 2" or equivalent. The marking shall be located adjacent to the terminals and shall be visible during wiring.		N/A
2.5	Where a fuse is used to provide Class 2, Limited Power Source, or TNV current limiting, it shall not be operator-accessible unless it is not interchangeable.		N/A
2.6.3.3	The first column on Table 2D modified to require, "Smaller of the RATED CURRENT of the equipment or the PROTECTIVE CURRENT RATING of the circuit under consideration."		N/A
2.7.1	<p>Suitable NEC/CEC branch circuit protection rated at the maximum circuit rating is required for all standard supply outlets and receptacles (such as supplied in power distribution units) if the supply branch circuit protection is not suitable.</p> <p>Power distribution transformers distributing power at 100 volts or more, and rated 10 kVA or more, require special transformer overcurrent protection.</p>	Considered	P
3.2	Wiring methods (terminals, leads, etc.) used for the connection of the equipment to the mains shall be in accordance with the NEC/CEC.		N/A
3.2.1	Power supply cords are required to have attachment plugs rated not less than 125 percent of the rated current of the equipment.		N/A
3.2.1.2	Equipment connected to a centralized d.c. power system, and having one pole of the DC mains input terminal connected to the main protective earthing terminal in the equipment, is required to comply with special earthing, wiring, marking and installation instruction requirements.		N/A



National Differences			
Clause	Requirement + Test	Result - Remark	Verdict
3.2.3	Permanent connection of equipment to the mains supply by a power supply cord is not permitted, except for certain equipment, such as ATMs.	The EUT is not such types	N/A
3.2.5	Power supply cords are required to be no longer than 4.5 m in length Minimum cord length is required to be 1.5 m, with certain constructions such as external power supplies allowed to consider both input and output cord lengths into the requirement. Flexible power supply cords are required to be compatible with Article 400 of the NEC, and Tables 11 and 12 of the CEC.		N/A
3.2.9	Permanently connected equipment is required to have a suitable wiring compartment and wire bending space.		N/A
3.3	Wiring terminals and associated spacings for field wiring connections shall comply with CSA C22.2 No. 0.		N/A
3.3.3	Wire binding screws are not permitted to attach conductors larger than 10 AWG (5.3 mm ²).	No wiring terminal	N/A
3.3.4	Terminals for permanent wiring, including protective earthing terminals, are required to be suitable for U.S./Canadian wire gauge sizes, rated 125 percent of the equipment rating, and be specially marked when specified (1.7.7).		N/A
3.3.5	First column of Table 3E revised to require "Smaller of the RATED CURRENT of the equipment or the PROTECTIVE CURRENT RATING of the circuit under consideration."		N/A
3.4.2	Motor control devices are required for cord-connected equipment with a motor if the equipment is rated more than 12 A, or if the motor has a nominal voltage rating greater than 120 V, or is rated more than 1/3 hp (locked rotor current over 43 A).	No such devices	N/A
3.4.8	Vertically-mounted disconnect switches and circuit breakers are required to have the "on" position indicated by the handle in the up position.	No such devices	N/A
3.4.11	For computer room applications, equipment with battery systems capable of supplying 750 VA for five minutes are required to have a battery disconnect means that may be connected to the computer room remote power-off circuit.		N/A
4.3.12	The maximum quantity of flammable liquid stored in equipment is required to comply with NFPA 30.	No such materials within the EUT	N/A



National Differences			
Clause	Requirement + Test	Result - Remark	Verdict
4.3.13.5	Equipment with lasers is required to meet the U.S. Code of Federal Regulations 21 CFR 1040 (and the Canadian Radiation Emitting Devices Act, REDR C1370).		N/A
4.7	For computer room applications, automated information storage systems with combustible media greater than 0.76 m ³ (27 cu ft) are required to have a provision for connection of either automatic sprinklers or a gaseous agent extinguishing system with an extended discharge.		N/A
4.7.3.1	For computer room applications, enclosures with combustible material measuring greater than 0.9 m ² (10 sq ft) or a single dimension greater than 1.8 m (6 ft) are required to have a flame spread rating of 50 or less. For other applications, enclosures with the same dimensions require a flame spread rating of 200 or less.		N/A
Annex H	Equipment that produces ionizing radiation is required to comply with the U.S. Code of Federal Regulations, 21 CFR 1020 (and the Canadian Radiation Emitting Devices Act, REDR C1370).	The EUT does not produce ionizing radiation	N/A
	OTHER DIFFERENCES		—
Sub-Clause	National Difference		—

National Differences			
Clause	Requirement + Test	Result - Remark	Verdict
1.5.1	<p>Some components and materials associated with the risk of fire, electric shock, or personal injury are required to have component or material ratings in accordance with the applicable national (U.S. and Canadian) component or material requirements. These components include:</p> <p>attachment plugs, battery packs (rechargeable type, used with transportable equipment), cathode ray tubes, circuit breakers, communication circuit accessories, connectors (used for current interruption of non-LPS circuits), cord sets and power supply cords, direct plug-in equipment, electrochemical capacitor modules (energy storage modules with ultracapacitors), enclosures (outdoor), flexible cords and cables, fuses (branch circuit), fuseholders, ground-fault current interrupters, industrial control equipment, insulating tape, interconnecting cables, lampholders, limit controls, printed wiring, protectors for communications circuits, receptacles, solid state controls, supplementary protectors, switches (including interlock switches), thermal cutoffs, thermostats, (multi-layer) transformer winding wire, surge protective devices, tubing, vehicle battery adapters, wire connectors, and wire and cables.</p>		P
1.6.1.2	<p>A circuit for connection to the DC Mains Supply is classified as a SELV Circuit, a TNV-2 Circuit or a Hazardous Voltage Circuit depending on the maximum operating voltage of the supply. This maximum operating voltage shall include consideration of the battery charging "float voltage" associated with the intended supply system, regardless of the marked power rating of the equipment.</p>		N/A
2.3.1	<p>For TNV-2 and TNV-3 circuits with other than ringing signals and with voltages exceeding 42.4 V_{peak} or 60 V_{d.c.}, the maximum acceptable current through a 2000 ohm resistor (or greater) connected across the voltage source with other loads disconnected is 7.1 mA peak or 30 mA d.c. under normal operating conditions.</p>	No TNV circuit within the EUT	N/A
2.3.2.1	<p>In the event of a single fault between TNV and SELV circuits, the limits of 2.2.3 apply to SELV Circuits and accessible conductive parts.</p>		N/A
2.6.3.4	<p>Protective bonding conductors of non-standard protective bonding constructions (e.g., printed circuit traces) may be subjected to the additional limited short circuit test conditions specified.</p>		N/A

National Differences			
Clause	Requirement + Test	Result - Remark	Verdict
4.2.8.1	Enclosures around CRTs with a face diameter of 160 mm or more are required to reduce the risk of injury due to the implosion of the CRT.	No such devices within the EUT	N/A
4.2.11	For equipment intended for mounting on racks and provided with slide/rails allowing the equipment to slide away from the rack for installation, service and maintenance, additional construction, performance and marking requirements are applicable to determine the adequacy of the slide/rails.		N/A
4.3.2	Equipment with handles is required to comply with special loading tests.	No such devices within the EUT	N/A
5.1.8.3	Equipment intended to receive telecommunication ringing signals is required to comply with a special touch current measurement tests.	No TNV circuit within the EUT	N/A
5.3.7	Internal (e.g., card cage) SELV circuit connectors and printed wiring board connectors that are accessible to the operator and that deliver power are to be overloaded. During abnormal operating testing, if a circuit is interrupted by the opening of a component, the test shall be repeated twice (three tests total) using new components as necessary.		N/A
6.4	Equipment intended for connection to telecommunication network outside plant cable is required to be protected against overvoltage from power line crosses in accordance with 6.4 and Annex NAC.		N/A
Annex EE	UL articulated accessibility probe (Fig EE.3) required for assessing accessibility to document/media shredders instead of the Figure 2A test finger.		N/A
Annex M.2	Continuous ringing signals up to 16 mA only are permitted if the equipment is subjected to special installation and performance restrictions.		N/A
Annex NAD	Equipment connected to a telecommunication and cable distribution networks and supplied with an earphone intended to be held against, or in the ear is required to comply with special acoustic pressure requirements.		N/A



National Differences			
Clause	Requirement + Test	Result - Remark	Verdict
Annex NAF	Document (paper) shredders likely to be used in a home or home office (Pluggable Equipment Type A plug configuration) are required to comply with additional requirements, including markings/instructions, protection against inadvertent reactivation of a safety interlock, disconnection from the mains supply (via provision of an isolating switch), and protection against operator access (accessibility determined via new accessibility probe & probe/wedge).		N/A

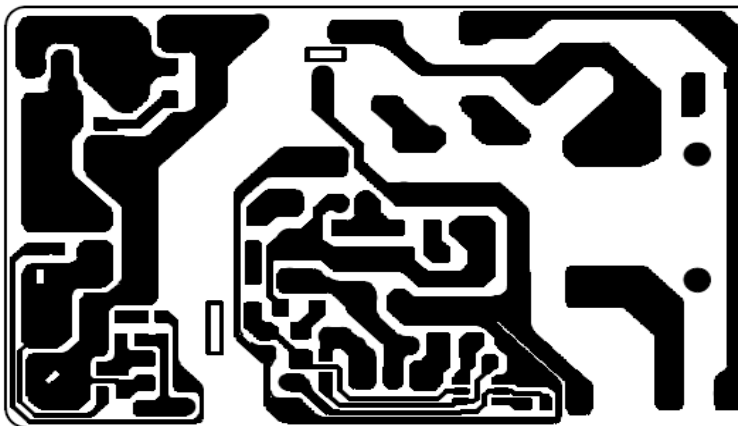
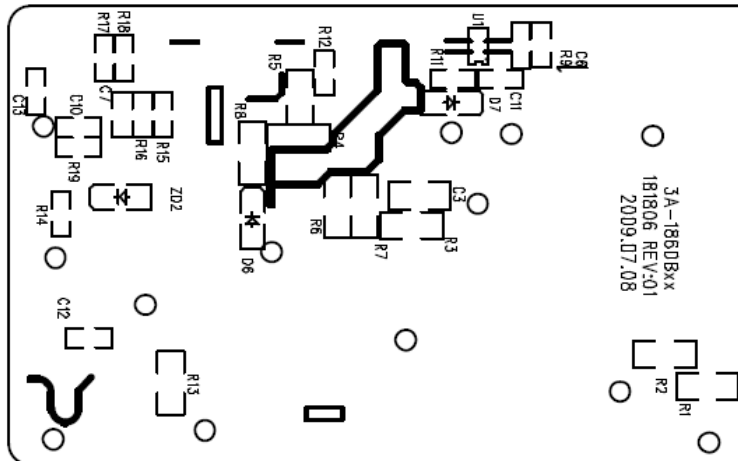
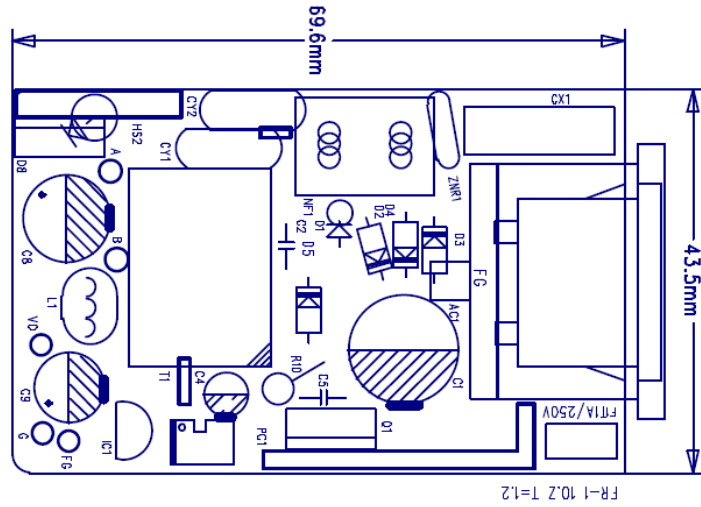

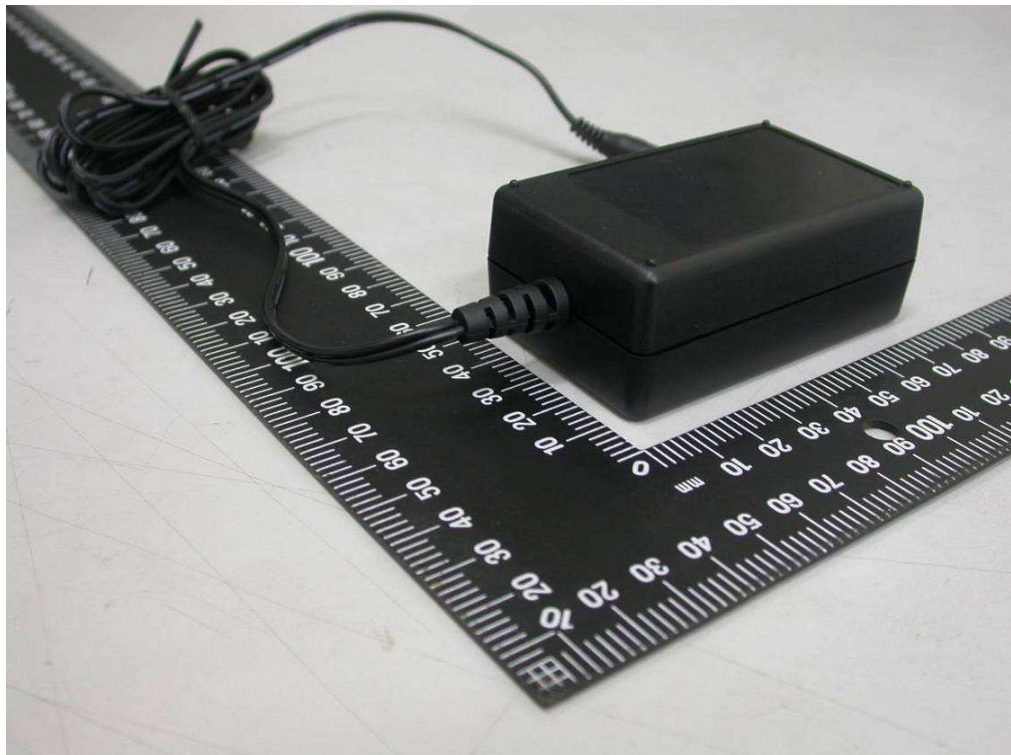

Models 3A-186DA05, 3A-186DA05A, 3A-186DA06

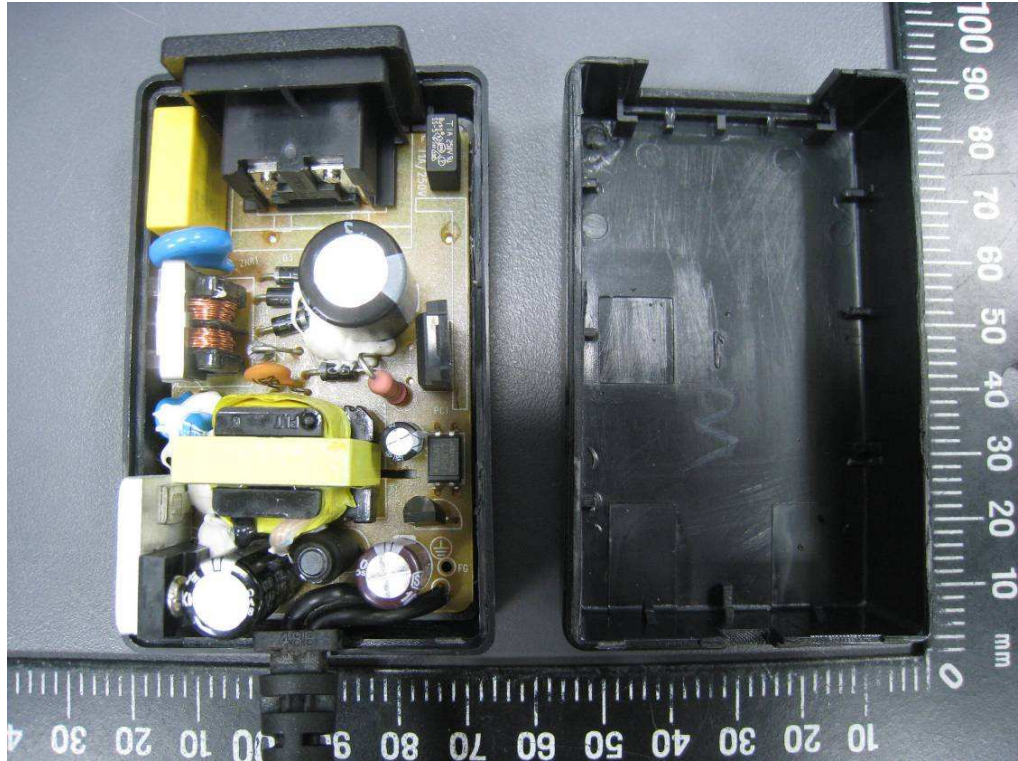

Models 3A-186DA05, 3A-186DA05A, 3A-186DA06

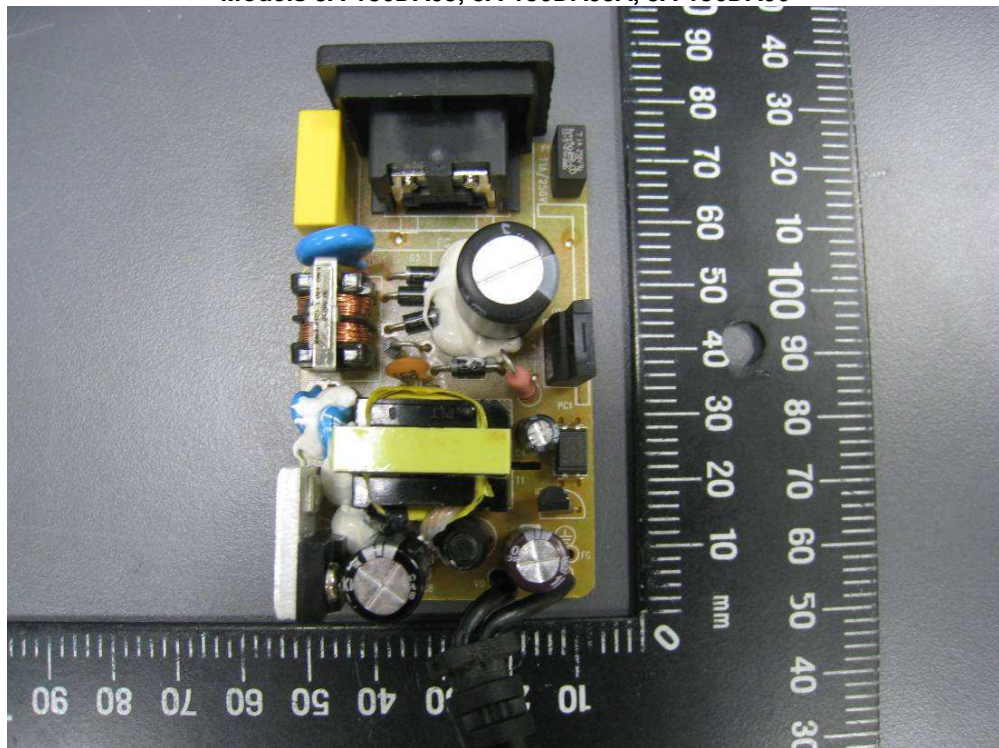

Models 3A-186DA12, 3A-186DA15

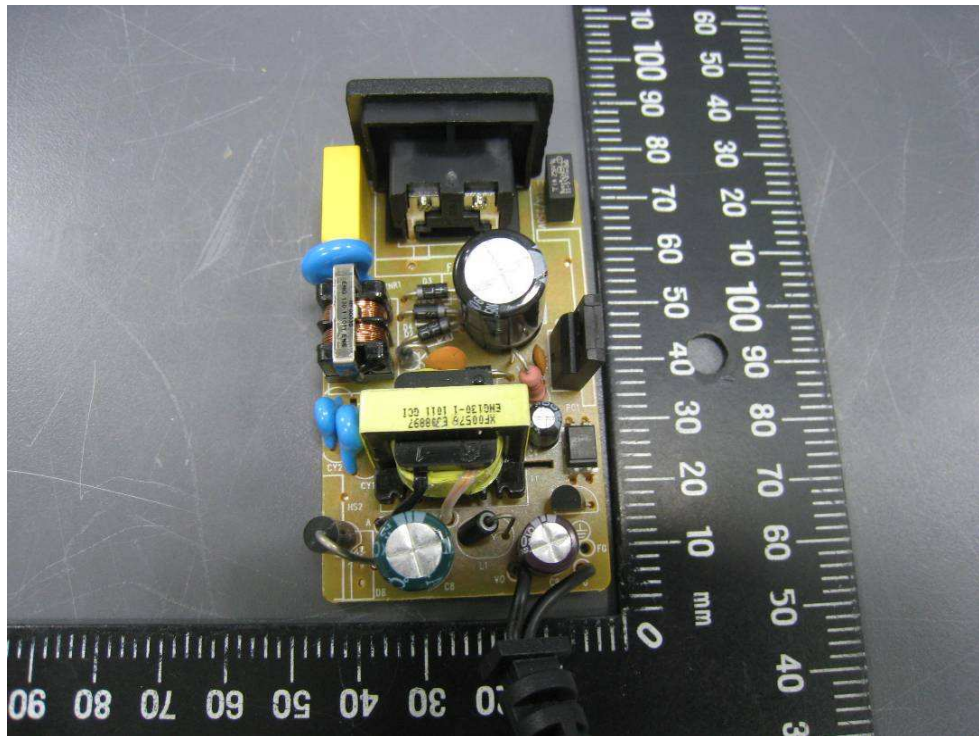

Models 3A-186DA12, 3A-186DA15

